



DEMO BOARD TEST REPORT

33W High Performance PD3.0 Charger with Power Switch KP22062 and Synchronous Rectifier KP40611

FEATURES

- Integrated with 650V GaN FET
- Support PD 3.0 and QC 3.0 Protocol
- Output voltage: 5V/9V/11V/12V/15V/20V
- Output current: 3A/3A/3A/2.5A/2A/1.5A
- Demo size: 26.5mm*26.5mm*25mm
- Average efficiency Meet DoE 6
- Standby power consumption <30mW
- Output voltage ripple <160mV
- EMI Meet EN55022B Class B with >6dB Margin
- ESD Meet IEC61000-4-2, Contact 9kV & Air 16kV
- Surge Meet IEC61000-4-5, DM 1.5kV & CM 2.5kV
- Stable operation without Audio Noise
- Integrated Protection Features of Auto-Recovery Mode

INTRODUCTION

KP22062 is a high performance quasi-resonant current mode power switch for flyback converter, which integrates a 650V GAN FET and turn on speed adjustment function. The KP22062 can adaptively work in green mode, burst mode and QR mode, which can make it easy to pass DoE 6 standard.

KP40611 is a high efficiency and reliability secondary side synchronous rectifier switch, which supports DCM, QR, CCM operation mode.

The demo board of KP22062+KP40611-D01 is typically designed for 33W PD3.0 charger with universal input (90-265Vac,50/60Hz). The demo board can achieve high efficiency, low standby power loss and meet the EN55022B EMI standard.

APPLICATIONS

- PD Charger

DEMO BOARD SEPCIFICATION

Description	Symbol	Min	Type	Max	Unit	Note	
Input Voltage	Vin	90		265	Vac	50/60Hz	
Output	Vout/Iout	5V/9V/11V/3A; 12V/2.5A; 15V/2A; 20V/1.5A					
Rate Output Power	Pout		33		W		
Ripple & Noise	Vripple			154	mVp-p	Cable end, 20MHz bandwidth	
Maximum Full Load Efficiency	η	>92			%	Board end @115V/230Vac	
Standby Power Consumption	Pst			29.5	mW	@265Vac	
Startup Time	Tst			97.4	ms	Tested at 90Vac/60Hz	
Conducted EMI Margin	CE		6		dB	EN55022 class B	
Radiated EMI Margin	RE		6		dB	EN55015 CDN	
Surge Test (Different/Common)			$\pm 1.5/2.5$		kV	Differential mode @ 230Vac/50Hz	
ESD (Contact/Air Discharge)	ESD		$\pm 9/16$		kV	On max output terminal	
Operating Ambient	Ta	0		40	°C		
Operating Humidity		5		95	%R.H.		

The table above shows the minimum acceptable performance of the design. Actual performance is listed in the results section.

Demo Board of KP22062+KP40611-D01-REV1.0

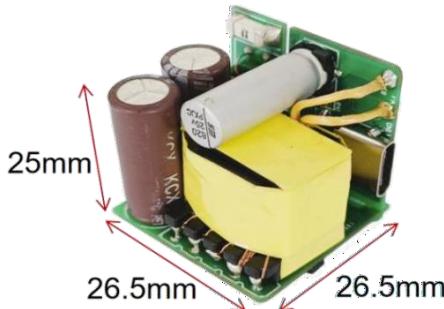

Board Size (mm): L x W x H = 26.5 x 26.5 x 25

Schematic

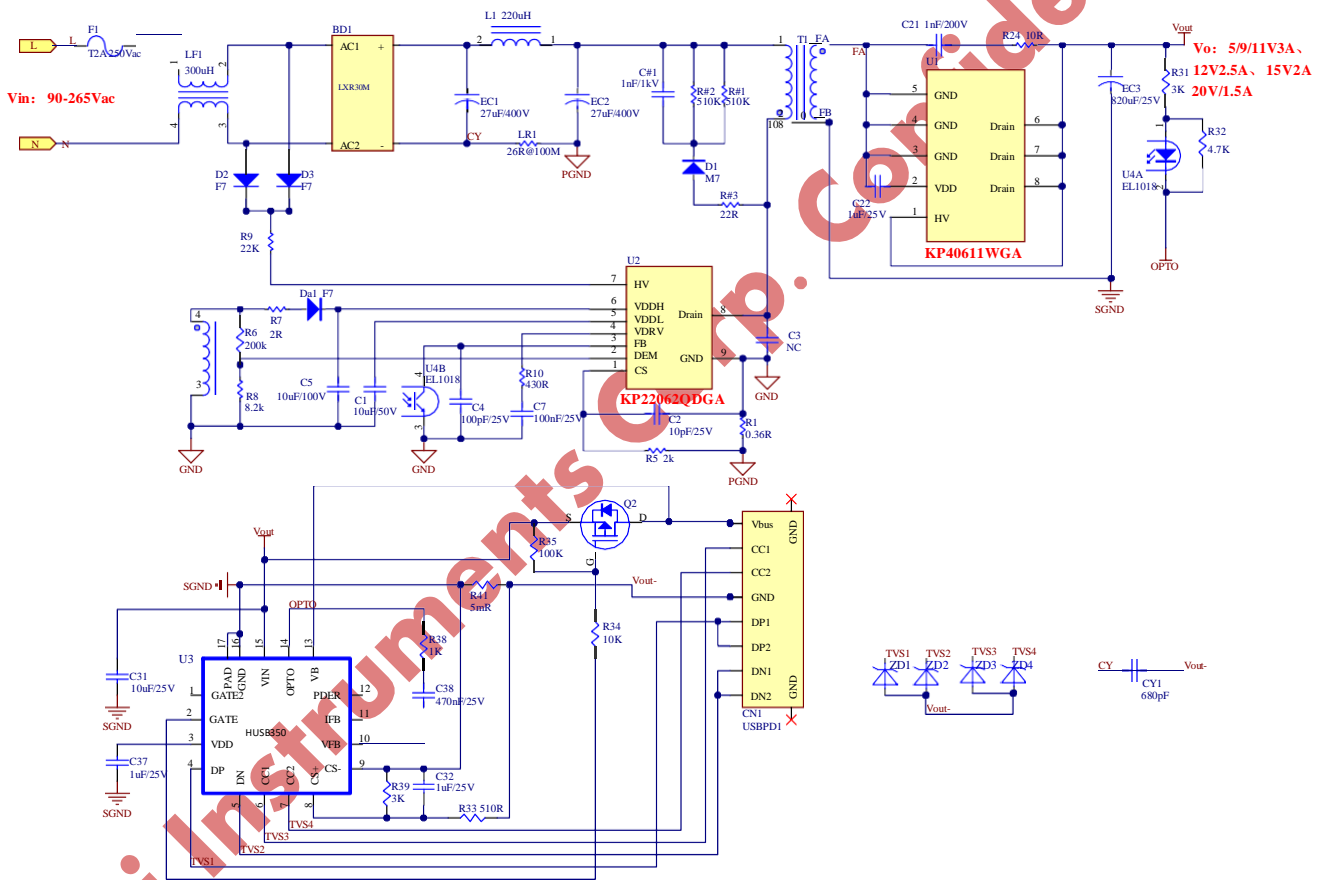

Printed Circuit Board Layout

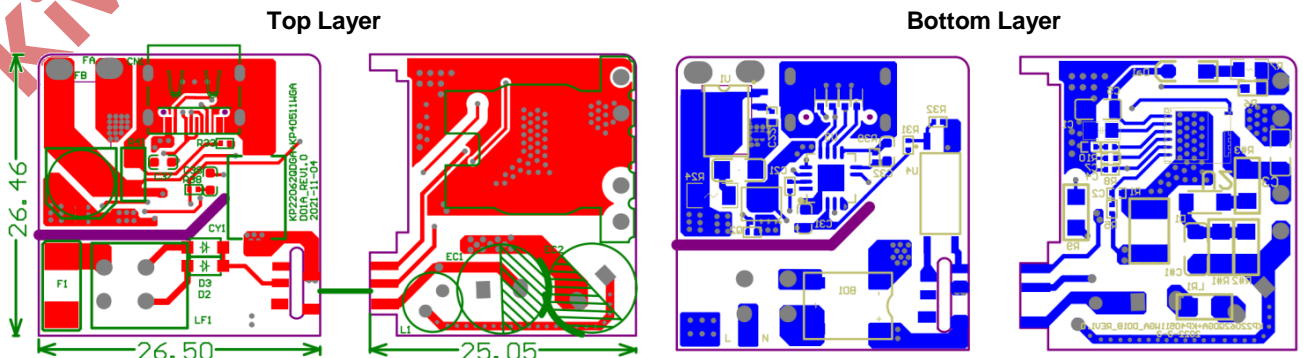



Bill of Material

No.	Designator	Value	Description	Package	Manufacturer	Part Number
1	CN1	TYPE-C	TYPE-C female 16P	TYPE-C-16P	Kinghelm	KH-TYPE-C-16P
2	F1	2A/250Vac	Fuse Fast 2A 250Vac 2410	2410	JDTfuse	JFC2410-1200TS
3	BD1	3A/1kV	Fast Recovery BRD 3A 1kV Z4PAK	Z4PAK	ZOWIE	LXR30M
4	LF1	0.3mH	Common Mode inductor	T6*3*3	Any	
5	L1	220µH	Inductor 220µH 0.1Ω 6*8 P3.0 +/-10%	5*7 P2.5	Any	
6	LR1	26R/100MHz	Magnetic bead 26R/100MHz 100mΩ 1A 1206 +/-25%	1206	FH	CBG321609U260T
7	U1	KP40611	Secondary Side Synchronous Rectifier	ASOP6	Kiwi Instruments	KP40611 WGA
8	U2	KP22062	High-performance Multi-Mode PWM Controller	DFN5X6-8L	Kiwi Instruments	KP22062 QDGA
9	U3	HUSB350	USB Type-C and PD Source Controller	QFN16	Hynetek	HUSB350 A
10	U4	EL1019	PHOTO TR 60mA 80V SOP-4L-4P 200%-400% SMD	SOP-4L-4P	Everlight	EL1019(TA)-VG
11	Q2	-45A/-30V	MOSFET -45A -30V PDFN3333 SMD	PDFN3333	CWT	CWT3122 A
12	D1	1A/1kV	DIO SI 1A 1kV SMA SMD	SMA	MDD	M7
13	D2, D3, Da1	1A/1kV	DIO FRD 1A 1kV SOD123 SMD	SOD123	DIYI	FFM107-M
14	R#1, R#2	510kΩ	RES SMD 1/4W, 5%, 1206	1206	Any	
15	R#3	22Ω	RES SMD 1/4W, 5% 1206	1206	Any	
16	R1	0.36Ω	RES SMD 1/2W, 1%, 1812	1812	Ever Ohms	
17	R5	2kΩ	RES SMD 1/16W, 5%, 0402	0402	Any	
18	R6	200kΩ	RES SMD 1/10W, 5%, 0603	0603	Any	
19	R7	2Ω	RES SMD 1/8W, 5%, 0805	0805	Any	
20	R8	8.2kΩ	RES SMD 1/16W, 5%, 0402	0402	Any	
21	R9	22kΩ	RES SMD 1/4W, 5%, 1206	1206	Any	
22	R10	430Ω	RES SMD 1/16W, 5%, 0402	0402	Any	
23	R24	10Ω	RES SMD 1/4W, 5%, 1206	1206	Any	
24	R31, R39	3kΩ	RES SMD 1/16W, 5%, 0402	0402	Any	
25	R32	4.7kΩ	RES SMD 1/16W, 5%, 0402	0402	Any	
26	R33	510Ω	RES SMD 1/16W, 5%, 0402	0402	Any	
27	R34	10kΩ	RES SMD 1/16W, 5%, 0402	0402	Any	
28	R35	100kΩ	RES SMD 1/16W, 5%, 0402	0402	Any	
29	R38	1kΩ	RES SMD 1/16W, 5%, 0402	0402	Any	
30	R41	5mΩ	RES SMD 1/4W, 1%, 1206	1206	Any	
31	EC1, EC2	27µF	ELE CAP 400V 27µF M 8*20 P3.5 105°C	8*20 P3.5	Yongming	
32	EC3	820µ	SOLID CAP 25V 820µF M 6.3*18 P3 105°C	6.3*18 P3	Yongming	
33	C#1	1nF	Ceramic CAP, 1kV, X7R 1206	1206	Any	
34	C1	10µF	Ceramic CAP, 50V, X7R 0805	0805	Any	
35	C2	10pF	Ceramic CAP, 25V, X7R 0402	0402	Any	
36	C3	NC	Ceramic CAP, 1kV, X7R 1206	1206	Any	
37	C4	100pF	Ceramic CAP, 25V, X7R 0402	0402	Any	



**33W High Performance PD3.0 Charger
with Power Switch KP22062 and Synchronous Rectifier KP40611**

38	C5	10 μ F	Ceramic CAP, 100V, X7R 1206	1206	Any	
39	C7	100nF	Ceramic CAP, 25V, X7R 0402	0402	Any	
40	C21	1nF	Ceramic CAP, 200V, X7R 0805	0805	Any	
41	C22, C32, C37	1 μ F	Ceramic CAP, 25V, X7R 0402	0402	Any	
42	C31	10 μ F	Ceramic CAP, 25V, X7R 0603	0603	Any	
43	C38	470nF	Ceramic CAP, 25V, X7R 0603	0603	Any	
44	CY1	680pF	Y1 CAP, 400V, SMD	SMD	TRX	MY1681K
45	ZD1, ZD2, ZD3, ZD4	5V	DIO TVS 5V SOD523 SMD	SOD523	Takcheong	ESD5Z5.0 VC
46	T1	ATQ1715	ATQ1715-5P 420 μ H			

Kiwi Instruments Corp. Confidential

Transformer Manufacture Guide

1 Electrical Diagram

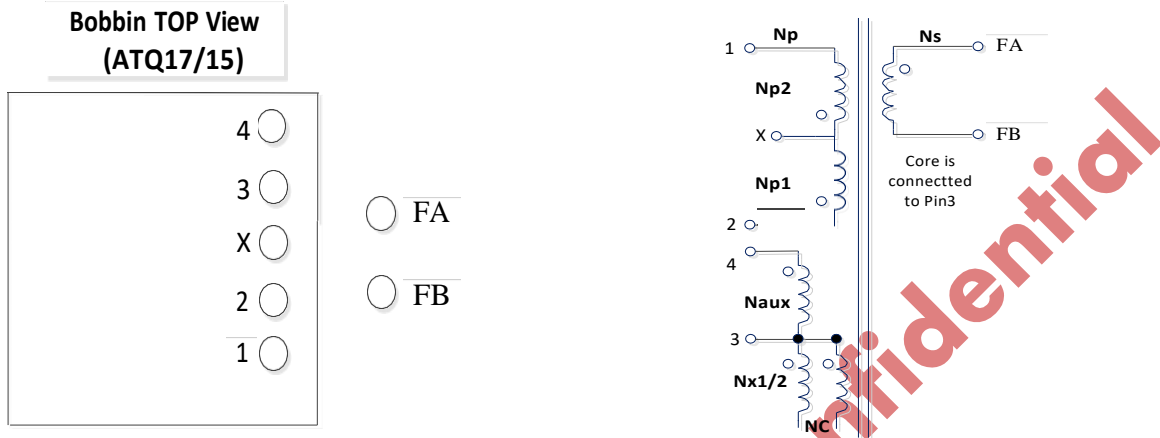

2 Winding Diagram

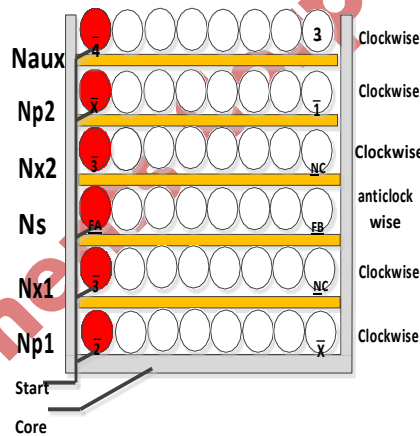

3 Winding Order

Number	Winding	Layer	Start	End	Wire Size(mm)	Turns	Note
1	Np1	Primary	Pin2	PinX	0.32*1P	24Ts	Dense
2	Nx1	Shield	Pin3	NC	0.12*4P	7Ts	Smooth Wound
3	Ns	Secondary	FA	FB	0.1*60P	7Ts	
4	Nx2	Shield	Pin3	NC	0.12*4P	7Ts	Smooth Wound
5	Np2	Primary	PinX	Pin1	0.32*1P	24Ts	Dense
6	Naux	Auxiliary	Pin4	Pin3	0.12*2P	21Ts	Dense



4 Electrical Specification

Items	Test Pin	Specification	Test Condition
Primary Inductance	Pins 2 - 1; other windings open	420 μ H(\pm 5%)	Ta=25 $^{\circ}$ C 40kHz/1V _{rm}
Leakage Inductance	Pins 2- 1; all other windings shorted	6 μ H	Ta=25 $^{\circ}$ C 40kHz/1V _{rm}
Turn Ratio	N _p (2-1): N _s : N _{aux}	48Ts: 7Ts: 21Ts	20kHz/1V
HI-POT HV Test	Primary to Secondary	3750Vac	5mA, 1Min
	Pin2-3	1000Vac	5mA, 1Min
	S-Aux	3750Vac	5mA, 1Min
Insulation Resistance	P-A	> 100 M Ω	DC500V
DC Resistance	Pins 2 - 1	0.4R Max	

5 BOM

Number	Materials	Specifications
1	Core	ATQ1715, TPG33, AE=48
2	Bobbin	ATQ1715, 5+0 Pin
3	Wire	Φ 0.32*1, 2UEW, Litz
4	Wire	Φ 0.12*4, 2UEW, Litz
5	Wire	Φ 0.12*2, 2UEW, Litz
6	Triple Insulation Wire	Φ 0.1*60, TIW-B, Litz
7	Duct tape	W=9mm, T=0.1mm



Test Result

1 Input Characteristics

1.1 Maximum Rated Input AC Current

Standard: 2A max. @ 90Vac input & full load.

Result: Pass

Vin (ac)	lin_rms (A)	lin_max limit (A)	Result
90V	0.701	2A	PASS

1.2 Inrush Current (Cold Start)

Standard: 30A max @ 265Vac input.

Result: Pass

Note: Tested @ 5V/3A.

Vin (ac)	Inrush (A)	lin_max limit (A)	Result
265V	17.5	30A	PASS

Waveforms:

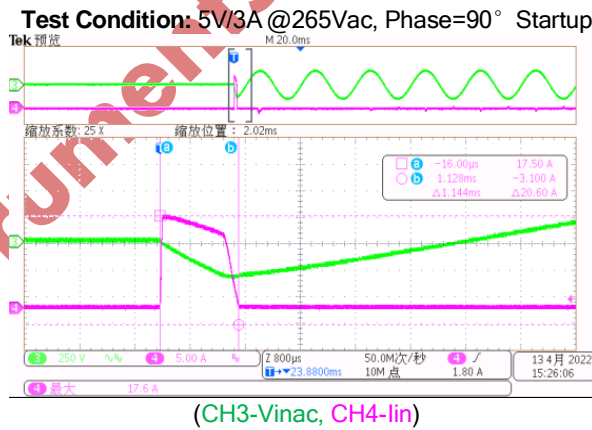

1.3 No Load Input Power Dissipation

Standard: While input 90Vac~265Vac and the output is no load, the input power loss must be less than 75mW.

Result: Pass



Vin (ac)	90V	115V	230V	265V	Green mode limit (mW)	Result
Pin(mW)	21.5	22.6	26.3	29.5	75mW	PASS

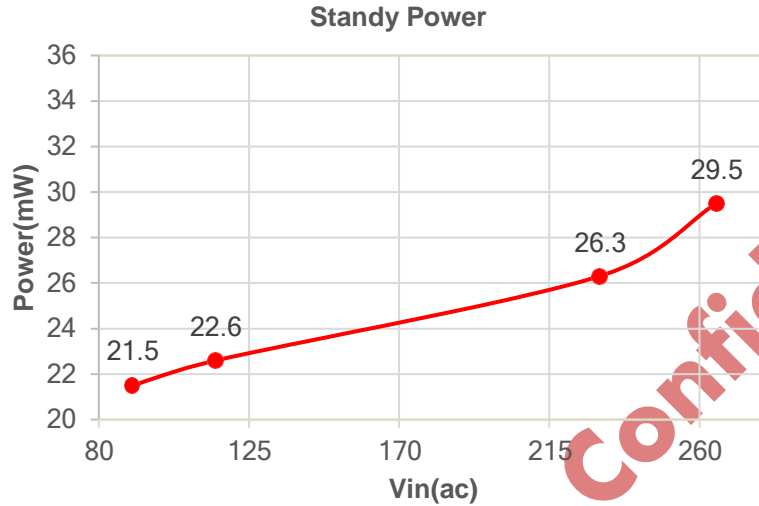

1.4 Efficiency

Standard: The average efficiency tested at the board end should pass DoE 6 with 1-2% margin @115Vac&230Vac.

Result: Pass

Test Data:

Output	Average Eff (%)					Result
	90Vac	115Vac	230Vac	265Vac	DoE 6	
20V	90.09	90.12	89.47	88.61	86.95	PASS
15V	90.96	91.33	90.58	89.77	86.95	PASS
12V	91.36	91.77	90.24	90.31	86.95	PASS
11V	91.55	92.19	90.91	90.05	87.21	PASS
9V	91.37	91.86	90.24	90.25	86.62	PASS
5V	91.01	91.24	89.29	88.16	81.39	PASS



Efficiency (20V/9.5A):

Vin (Vac)	Fline (Hz)	Pin (W)	Vout (V)	Iout(A)	Pout(W)	Eff (%)	Eff_AVG (%)	DoE 6 (%)
90	60	33.27	20.339	1.496	30.419	91.43	90.09	86.95
		25.00	20.365	1.121	22.822	91.29		
		16.80	20.358	0.746	15.189	90.41		
		8.65	20.334	0.371	7.542	87.21		
115		33.02	20.333	1.496	30.409	92.09	90.12	
		24.93	20.380	1.121	22.838	91.61		
		16.78	20.353	0.746	15.184	90.49		
		8.74	20.335	0.371	7.542	86.26		
230	50	33.07	20.310	1.496	30.374	91.85	89.47	
		25.15	20.356	1.121	22.811	90.70		
		17.15	20.367	0.746	15.195	88.60		
		8.69	20.321	0.371	7.536	86.72		
265		33.27	20.329	1.496	30.403	91.38	88.61	
		25.41	20.379	1.121	22.836	89.87		
		17.37	20.362	0.746	15.191	87.46		
		8.79	20.320	0.371	7.536	85.74		

Efficiency (15V/2A):

Vin (Vac)	Fline(Hz)	Pin(W)	Vout(V)	Iout(A)	Pout(W)	Eff (%)	Eff_AVG(%)	DoE 6(%)
90	60	33.26	15.280	1.991	30.428	91.49	90.96	86.95
		24.97	15.303	1.496	22.895	91.69		
		16.51	15.297	0.986	15.086	91.38		
		8.39	15.238	0.492	7.493	89.30		
115		33.00	15.326	1.991	30.520	92.49	91.33	
		24.84	15.328	1.496	22.932	92.32		
		16.45	15.288	0.986	15.077	91.66		
		8.43	15.239	0.492	7.494	88.87		
230	50	33.04	15.308	1.991	30.484	92.27	90.58	
		25.02	15.314	1.496	22.911	91.57		
		16.77	15.290	0.986	15.079	89.92		
		8.46	15.236	0.492	7.494	88.58		
265		33.30	15.340	1.991	30.547	91.73	89.77	
		25.22	15.320	1.496	22.921	90.88		
		16.96	15.282	0.986	15.072	88.87		
		8.55	15.228	0.492	7.489	87.60		



Efficiency

Vin (Vac)	Fline(Hz)	Pin(W)	Vout(V)	Iout(A)	Pout(W)	Eff (%)	Eff_AVG(%)	DoE 6(%)
90	60	33.49	12.276	2.487	30.528	91.16	91.36	86.95
		25.06	12.312	1.871	23.037	91.93		
		16.59	12.275	1.241	15.238	91.85		
		8.25	12.198	0.612	7.467	90.50		
115		33.14	12.308	2.487	30.608	92.36	91.77	
		24.91	12.308	1.871	23.031	92.46		
		16.55	12.277	1.242	15.242	92.10		
		8.28	12.196	0.612	7.468	90.16		
230	50	33.26	12.342	2.487	30.693	92.28	90.24	
		25.13	12.321	1.871	23.055	91.74		
		16.79	12.263	1.242	15.22	90.68		
		8.66	12.195	0.612	7.467	86.23		
265		33.51	12.357	2.487	30.733	91.71	90.31	
		25.21	12.302	1.871	23.022	91.32		
		16.97	12.258	1.242	15.220	89.69		
		8.44	12.196	0.613	7.470	88.51		

Efficiency (11V/3A):

Vin (Vac)	Fline(Hz)	Pin(W)	Vout(V)	Iout(A)	Pout(W)	Eff (%)	Eff_AVG(%)	DoE 6(%)
90	60	37.296	11.277	2.996	33.785	90.59	91.55	87.21
		27.7	11.319	2.247	25.433	91.82		
		18.33	11.294	1.497	16.907	92.24		
		9.15	11.201	0.748	8.378	91.57		
115		36.75	11.304	2.996	33.866	92.15	92.19	
		27.48	11.334	2.247	25.467	92.68		
		18.26	11.286	1.497	16.895	92.53		
		9.16	11.195	0.748	8.373	91.42		
230	50	36.69	11.335	2.996	33.959	92.56	90.91	
		27.72	11.348	2.247	25.498	91.99		
		18.52	11.275	1.497	16.878	91.14		
		9.52	11.194	0.748	8.373	87.95		
265		36.92	11.352	2.996	34.01	92.12	90.05	
		27.77	11.322	2.247	25.44	91.61		
		18.71	11.269	1.497	16.869	90.16		
		9.70	11.192	0.748	8.371	86.31		



**33W High Performance PD3.0 Charger
with Power Switch KP22062 and Synchronous Rectifier KP40611**

Efficiency (9V/3A):

Vin (Vac)	Fline(Hz)	Pin(W)	Vout(V)	Iout(A)	Pout(W)	Eff (%)	Eff_AVG(%)	DoE 6(%)
90	60	30.67	9.284	2.997	27.82	90.71	91.37	86.62
		22.75	9.289	2.247	20.874	91.76		
		15.05	9.236	1.497	13.829	91.89		
		7.50	9.141	0.748	6.835	91.13		
115		30.32	9.307	2.997	27.889	91.98	91.86	
		22.61	9.302	2.247	20.906	92.46		
		15.00	9.232	1.497	13.824	92.17		
		7.53	9.139	0.748	6.835	90.81		
230	50	30.39	9.332	2.997	27.965	92.02	90.24	
		22.80	9.294	2.248	20.888	91.61		
		15.23	9.222	1.498	13.809	90.67		
		7.89	9.139	0.748	6.836	86.65		
265		30.56	9.335	2.997	27.976	91.55	90.25	
		22.96	9.285	2.248	20.869	90.90		
		15.37	9.218	1.498	13.805	89.82		
		7.71	9.145	0.748	6.841	88.73		

Efficiency (5V/3A):

Vin (Vac)	Fline(Hz)	Pin(W)	Vout(V)	Iout(A)	Pout(W)	Eff (%)	Eff_AVG(%)	DoE 6(%)
90	60	17.81	5.389	2.998	16.154	90.70	91.01	81.39
		13.12	5.325	2.248	11.972	91.26		
		8.62	5.261	1.498	7.882	91.40		
		4.29	5.195	0.749	3.890	90.67		
115		17.66	5.389	2.998	16.154	91.48	91.24	
		13.06	5.324	2.249	11.970	91.63		
		8.63	5.259	1.499	7.881291647	91.31		
		4.30	5.195	0.749	3.890	90.54		
230	50	17.82	5.389	2.998	16.156	90.66	89.29	
		13.29	5.324	2.249	11.971	90.08		
		8.89	5.260	1.499	7.881	88.66		
		4.43	5.194	0.749	3.890	87.74		
265		17.94	5.388	2.998	16.153	90.04	88.16	
		13.43	5.323	2.249	11.969	89.13		
		9.02	5.260	1.499	7.882	87.39		
		4.52	5.196	0.749	3.891	86.09		

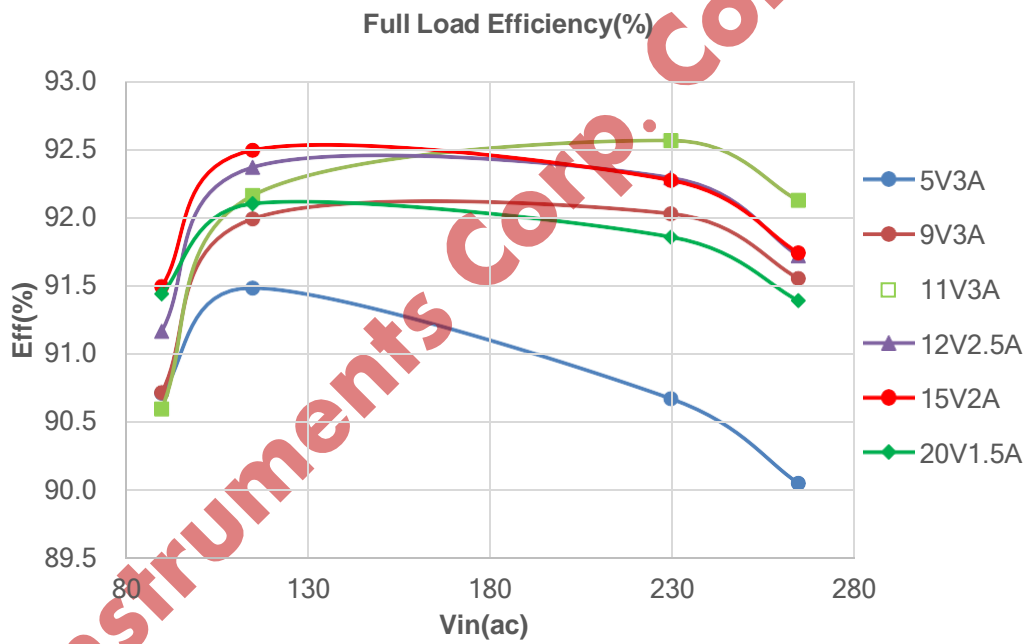
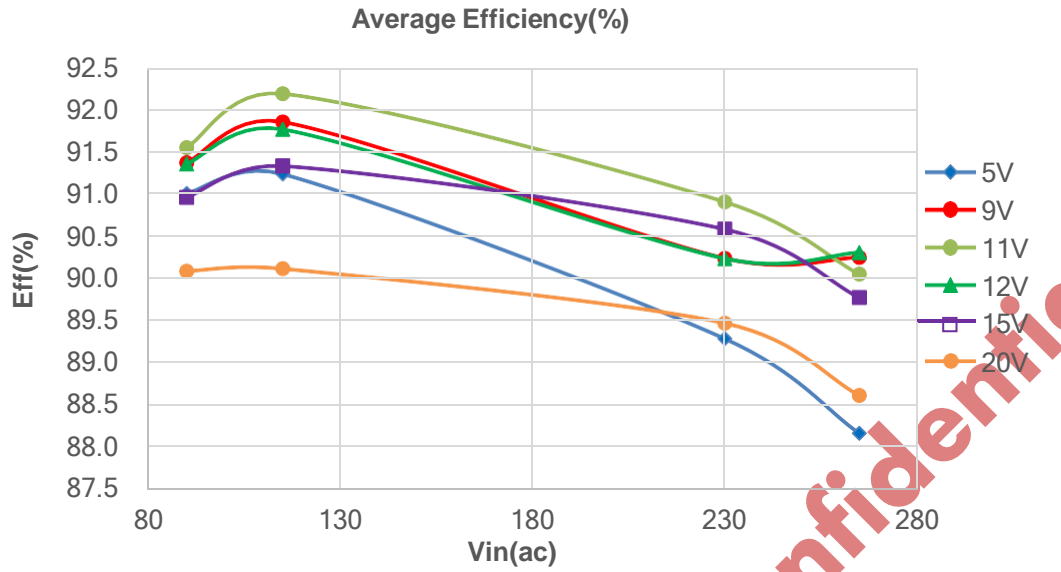



2 Output Characteristics

2.1 Output Line Regulation and Load Regulation

Standard: Under the input voltage 90Vac~265Vac, line regulation <6%, load regulation <6%. The output voltage is tested at the output cap end.

Result: Pass

Input Voltage	For Vo=20V / Output Voltage(V)					Load Regulation
	0% Load	25% Load	50% Load	75% Load	Full Load	
90Vac/60Hz	20.217	20.219	20.189	20.128	20.079	0.70%
115Vac/60Hz	20.235	20.266	20.229	20.203	20.133	0.66%
230Vac/50Hz	20.234	20.239	20.167	20.138	20.094	0.72%
264Vac/50Hz	20.25	20.263	20.26	20.228	20.111	0.76%
Line Regulation	0.16%	0.23%	0.46%	0.50%	0.27%	
Input Voltage	For Vo=15V / Output Voltage(V)					Load Regulation
	0% Load	25% Load	50% Load	75% Load	Full Load	
90Vac/60Hz	15.158	15.163	15.158	15.116	15.041	0.81%
115Vac/60Hz	15.16	15.181	15.17	15.15	15.091	0.60%
230Vac/50Hz	15.153	15.163	15.135	15.102	15.064	0.66%
264Vac/50Hz	15.162	15.163	15.163	15.144	15.107	0.37%
Line Regulation	0.06%	0.12%	0.23%	0.32%	0.44%	
Input Voltage	For Vo=12V / Output Voltage(V)					Load Regulation
	0% Load	25% Load	50% Load	75% Load	Full Load	
90Vac/60Hz	12.122	12.128	12.126	12.082	12.002	1.05%
115Vac/60Hz	12.123	12.136	12.147	12.109	12.046	0.84%
230Vac/50Hz	12.121	12.126	12.126	12.1	12.036	0.75%
264Vac/50Hz	12.121	12.12	12.12	12.109	12.061	0.50%
Line Regulation	0.02%	0.13%	0.22%	0.22%	0.49%	
Input Voltage	For Vo=11V / Output Voltage(V)					Load Regulation
	0% Load	25% Load	50% Load	75% Load	Full Load	
90Vac/60Hz	11.102	11.115	11.102	11.051	10.901	1.96%
115Vac/60Hz	11.105	11.114	11.12	11.088	10.984	1.24%



33W High Performance PD3.0 Charger
with Power Switch KP22062 and Synchronous Rectifier KP40611

230Vac/50Hz	11.104	11.107	11.1	11.07	11.014	0.84%
264Vac/50Hz	11.107	11.11	11.096	11.084	11.034	0.69%
Line Regulation	0.05%	0.07%	0.22%	0.33%	1.22%	
Input Voltage	For Vo=9V / Output Voltage(V)					Load Regulation
	0% Load	25% Load	50% Load	75% Load	Full Load	
90Vac/60Hz	9.062	9.07	9.072	9.035	8.977	1.06%
115Vac/60Hz	9.064	9.061	9.084	9.072	9.004	0.89%
230Vac/50Hz	9.063	9.066	9.067	9.055	9.031	0.40%
264Vac/50Hz	9.065	9.065	9.064	9.053	9.032	0.37%
Line Regulation	0.03%	0.10%	0.22%	0.41%	0.61%	
Input Voltage	For Vo=5V / Output Voltage(V)					Load Regulation
	0% Load	25% Load	50% Load	75% Load	Full Load	
90Vac/60Hz	5.126	5.12	5.113	5.107	5.102	0.47%
115Vac/60Hz	5.125	5.119	5.114	5.108	5.102	0.45%
230Vac/50Hz	5.125	5.118	5.112	5.106	5.102	0.45%
264Vac/50Hz	5.125	5.119	5.113	5.107	5.102	0.45%
Line Regulation	0.02%	0.04%	0.04%	0.04%	0.00%	

Line Regulation@Full Load

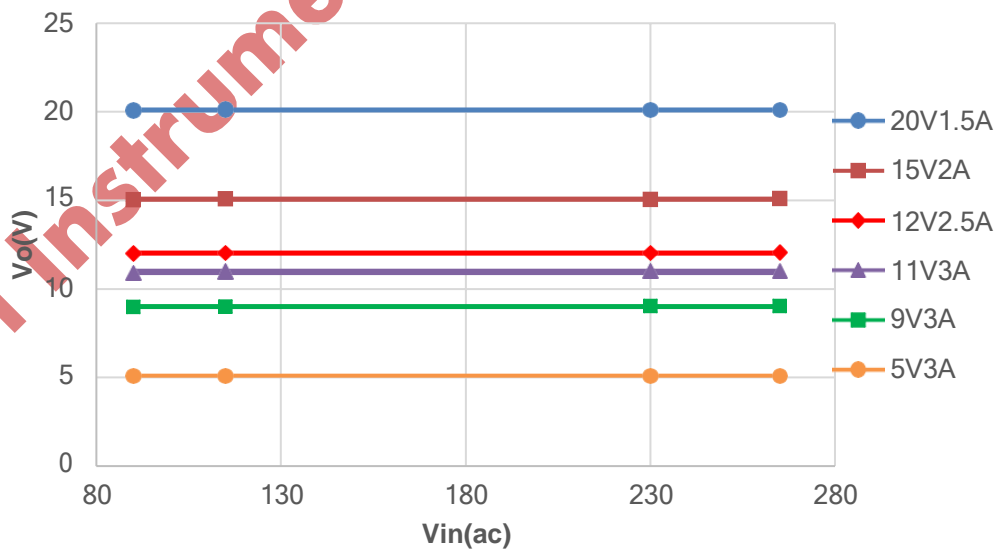

Load Regulation@230Vac

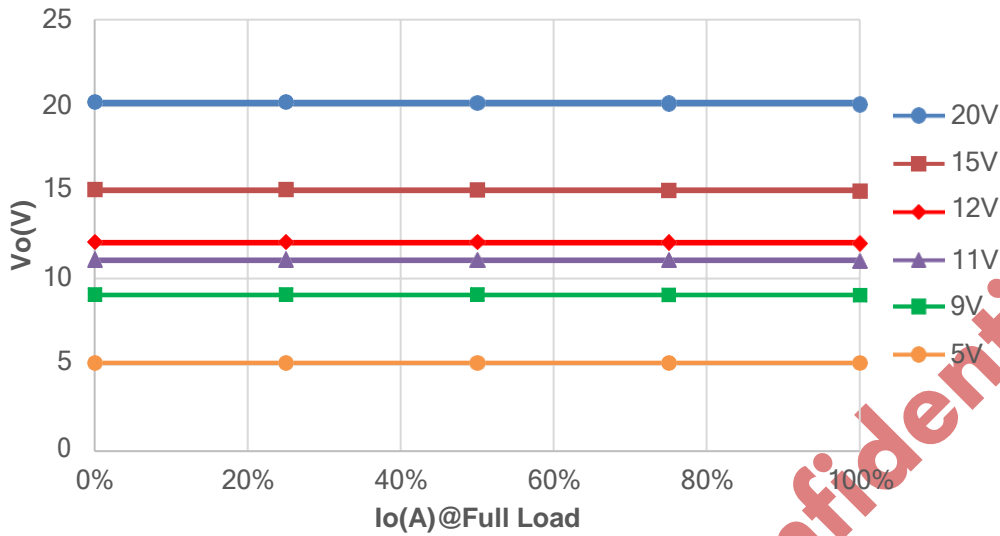

2.2 Ripple & Noise

Standard: Under the input voltage 90Vac~265Vac, $V_{ripple_max} < 200mV$.

Result: Pass

Note: Ripple & noise are measured at the 1 m line end with a 0.1 μ F/50V ceramic cap paralleled with a 10 μ F/50V electrolytic cap. Bandwidth is limited to 20Mhz.

Input Voltage	No Load Ripple(mV)					
	5V/0A	9V/0A	11V/0A	12V/0A	15V/0A	20V/0A
90Vac/60Hz	63.2	60.8	59.2	57.6	55.2	50.4
115Vac/60Hz	68	62.4	62.4	60	58.4	52.8
230Vac/50Hz	72.8	73.6	74.4	72.8	68.8	64
265Vac/50Hz	80.8	80	76	77.6	74.4	72
Input Voltage	Full Load Ripple(mV)					
	5V/3A	9V/3A	11V/3A	12V/2.5A	15V/2A	20V/1.5A
90Vac/60Hz	102	128	154	134	130	140
115Vac/60Hz	96	100	110	108	114	110
230Vac/50Hz	134	124	116	118	108	106
265Vac/50Hz	120	126	128	126	116	108

Waveforms:

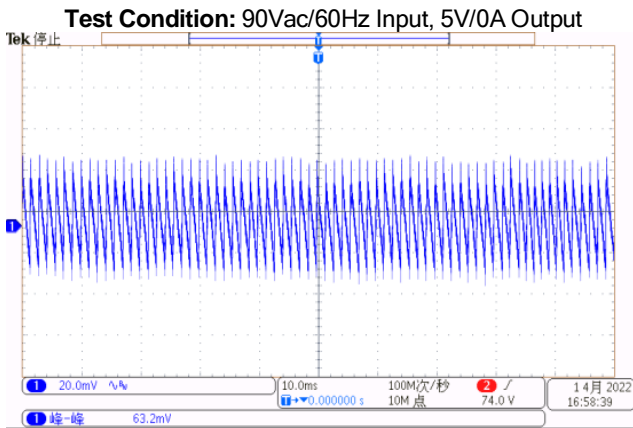

(CH1- Vripple)

Comments: Vripple=63.2mV

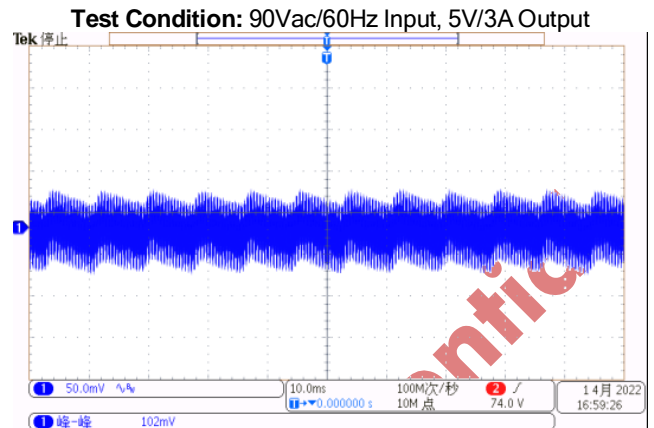

(CH1- Vripple)

Comments: Vripple=102mV

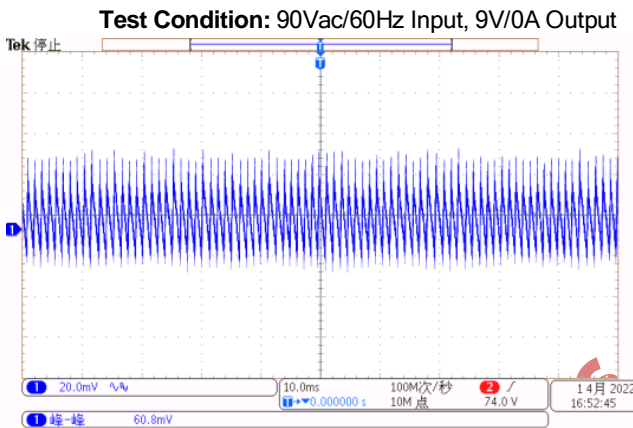

(CH1- Vripple)

Comments: Vripple=60.8mV

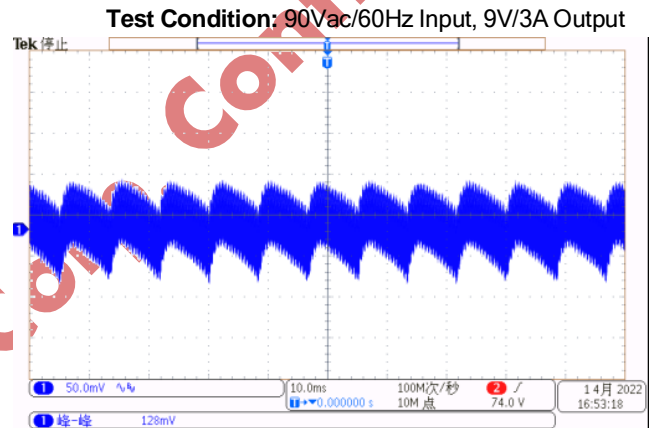

(CH1- Vripple)

Comments: Vripple=128mV

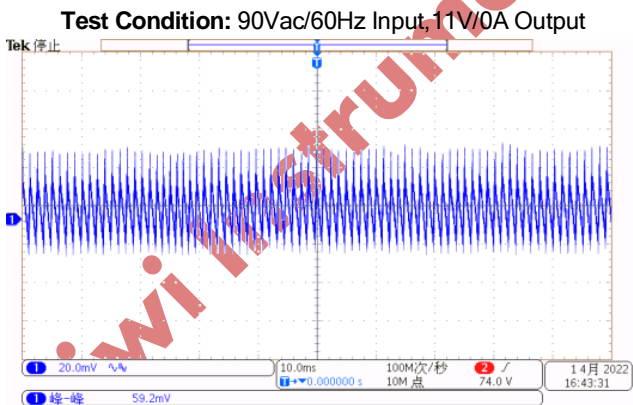

(CH1- Vripple)

Comments: Vripple=59.2mV

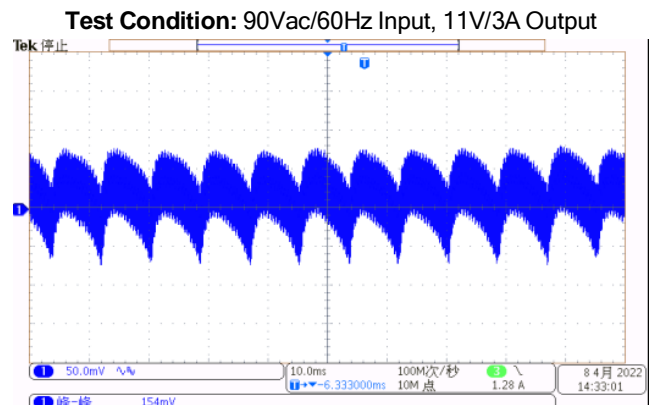

(CH1- Vripple)

Comments: Vripple=154mV



Demo Board Test Report
33W High Performance PD3.0 Charger
with Power Switch KP22062 and Synchronous Rectifier KP40611

Test Condition: 90Vac/60Hz Input, 12V/0A Output

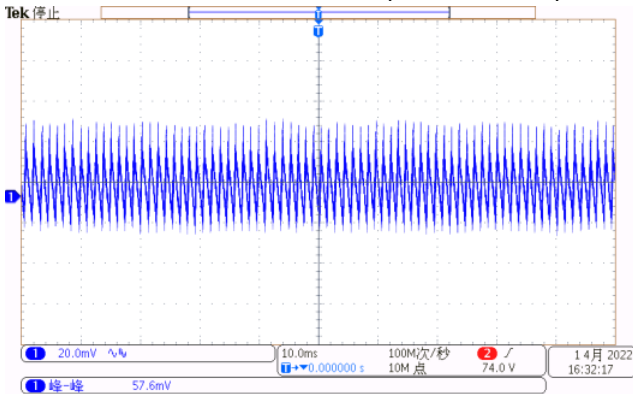

(CH1- Vripple)

Comments: Vripple=57.6mV

Test Condition: 90Vac/60Hz Input, 12V/2.5A Output

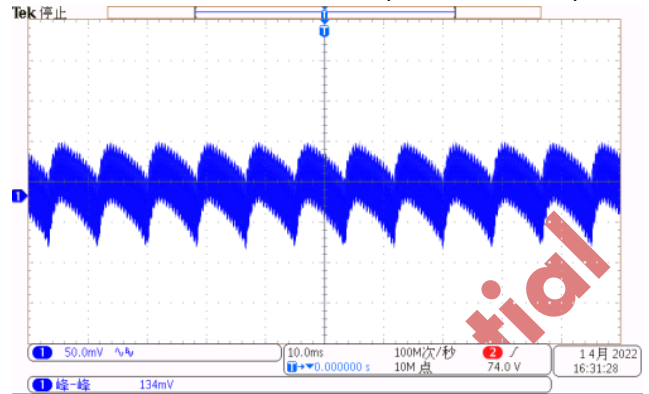

(CH1- Vripple)

Comments: Vripple=134mV

Test Condition: 90Vac/60Hz Input, 15V/0A Output

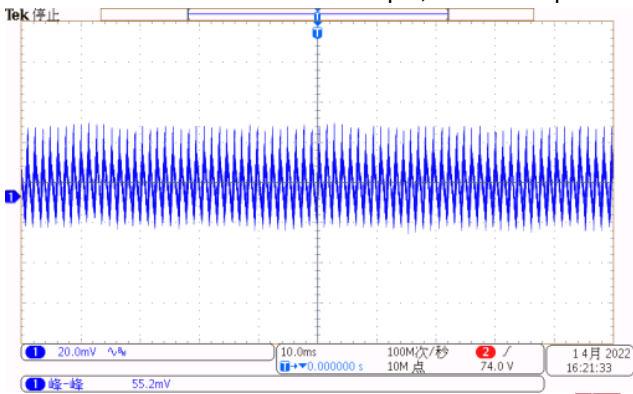

(CH1- Vripple)

Comments: Vripple=55.2mV

Test Condition: 90Vac/60Hz Input, 15V/2A Output

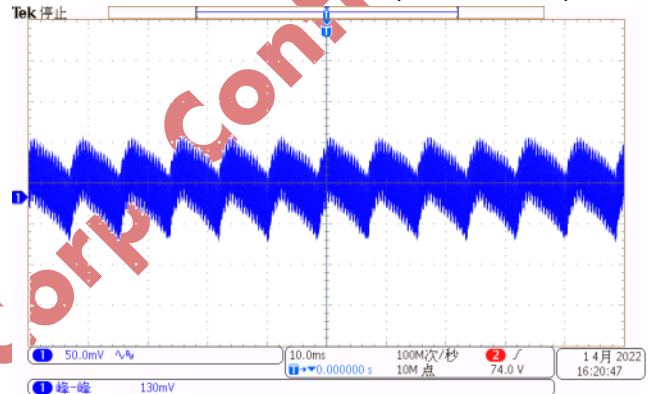

(CH1- Vripple)

Comments: Vripple=130mV

Test Condition: 90Vac/60Hz Input, 20V/0A Output

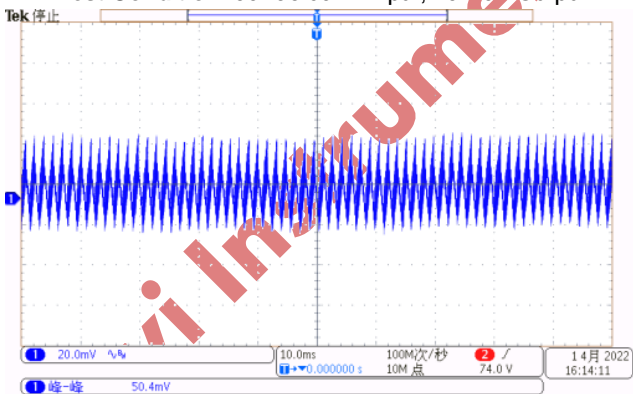

(CH1- Vripple)

Comments: Vripple=50.4mV

Test Condition: 90Vac/60Hz Input, 20V/1.5A Output

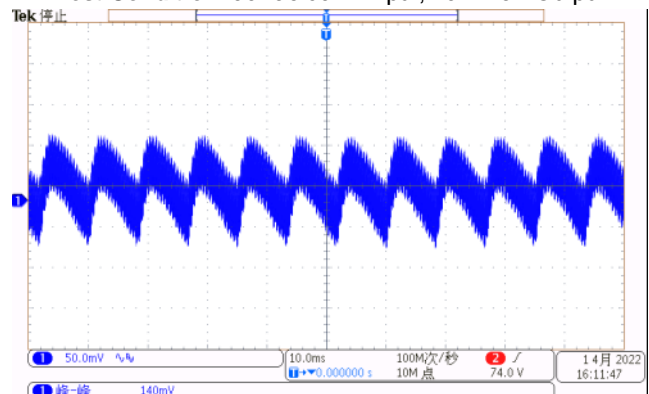

(CH1- Vripple)

Comments: Vripple=140mV



33W High Performance PD3.0 Charger
with Power Switch KP22062 and Synchronous Rectifier KP40611

Test Condition: 115Vac/60Hz Input, 5V/0A Output

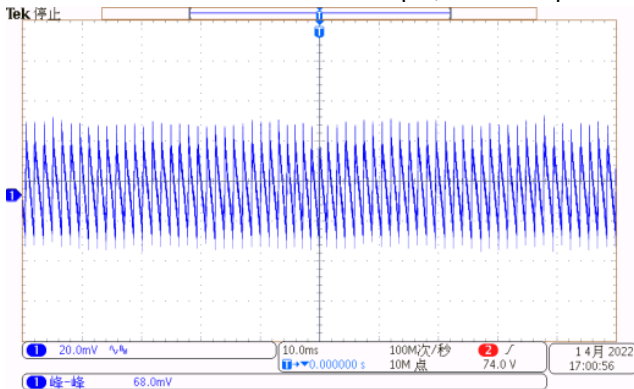

(CH1- Vripple)

Comments: Vripple=68mV

Test Condition: 115Vac/60Hz Input, 5V/3A Output

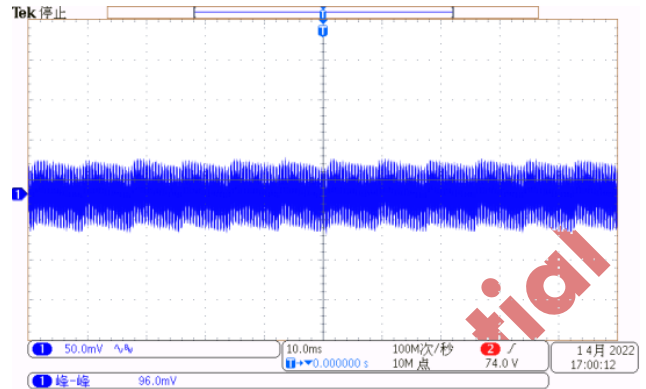

(CH1- Vripple)

Comments: Vripple=96mV

Test Condition: 115Vac/60Hz Input, 9V/0A Output

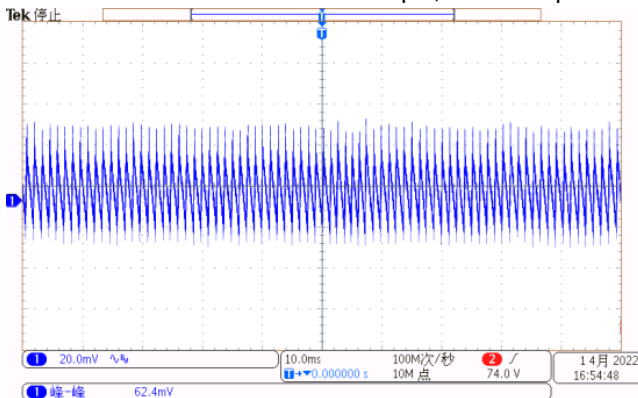

(CH1- Vripple)

Comments: Vripple=62.4mV

Test Condition: 115Vac/60Hz Input, 9V/3A Output

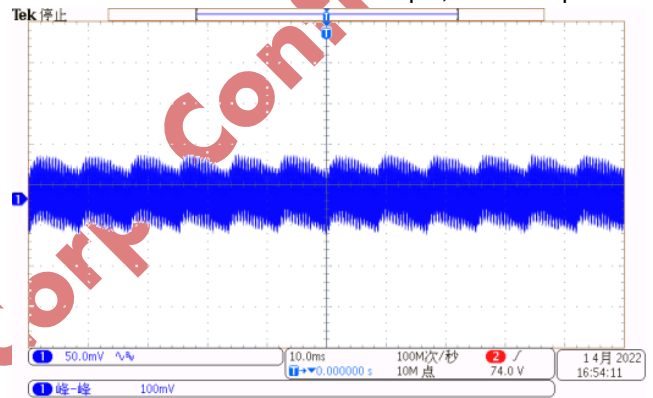

(CH1- Vripple)

Comments: Vripple=100mV

Test Condition: 115Vac/60Hz Input, 11V/0A Output

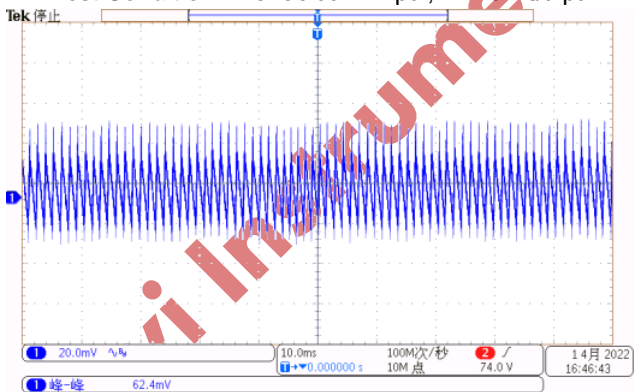

(CH1- Vripple)

Comments: Vripple=62.4mV

Test Condition: 115Vac/60Hz Input, 11V/3A Output

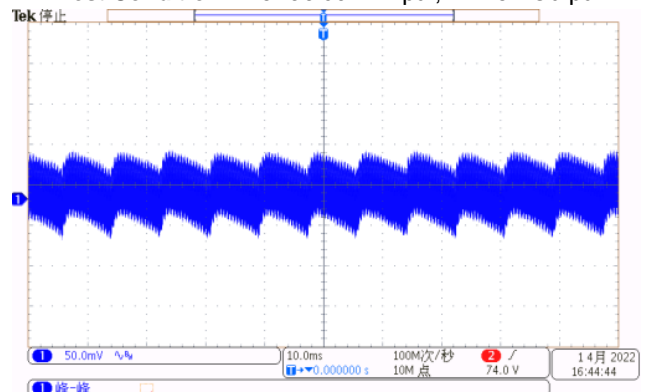

(CH1- Vripple)

Comments: Vripple=110mV



Demo Board Test Report
33W High Performance PD3.0 Charger
with Power Switch KP22062 and Synchronous Rectifier KP40611

Test Condition: 115Vac/60Hz Input, 12V/0A Output

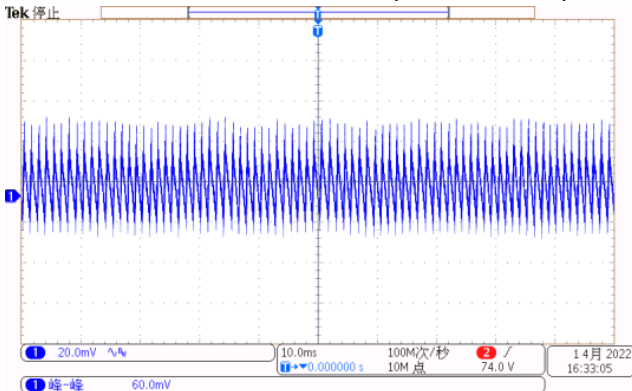

(CH1- Ripple)

Comments: Vripple=60mV

Test Condition: 115Vac/60Hz Input, 12V/2.5A Output

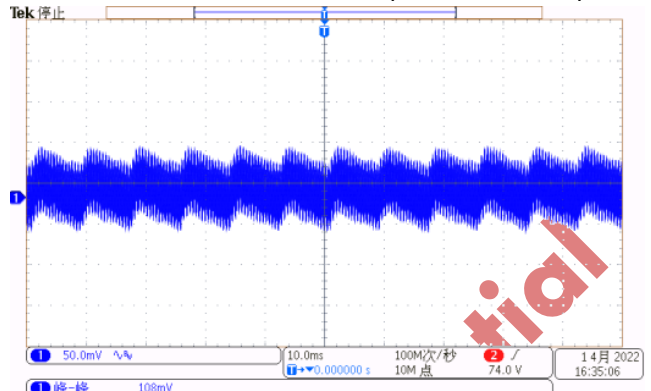

(CH1- Ripple)

Comments: Vripple=108mV

Test Condition: 115Vac/60Hz Input, 15V/0A Output

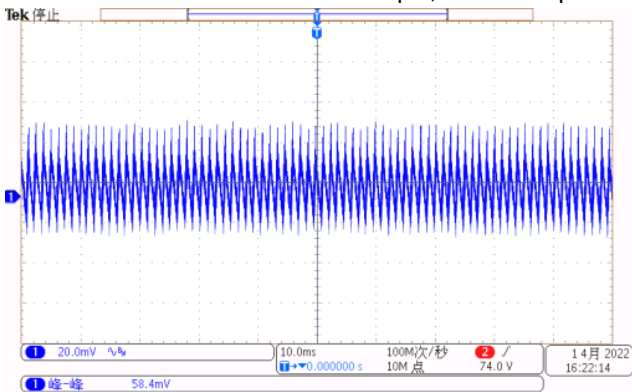

(CH1- Ripple)

Comments: Vripple=58.4mV

Test Condition: 115Vac/60Hz Input, 15V/2A Output

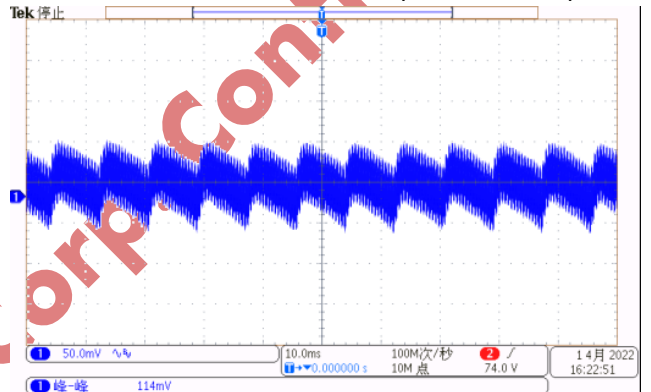

(CH1- Ripple)

Comments: Vripple=114mV

Test Condition: 115Vac/60Hz Input, 20V/0A Output

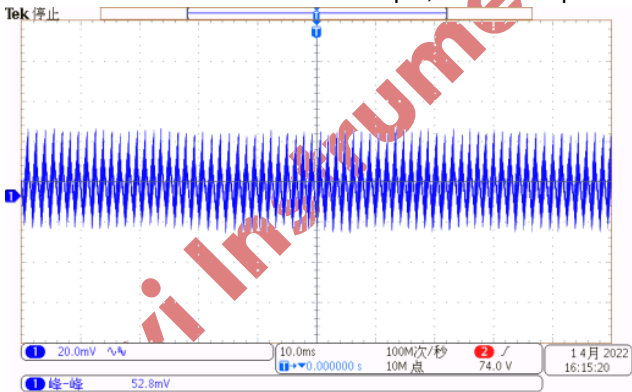

(CH1- Ripple)

Comments: Vripple=52.8mV

Test Condition: 115Vac/60Hz Input, 20V/1.5A Output

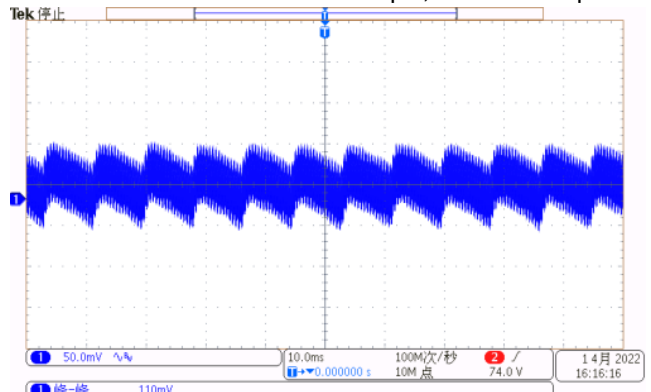

(CH1- Ripple)

Comments: Vripple=110mV



Test Condition: 230Vac/50Hz Input, 5V/0A Output

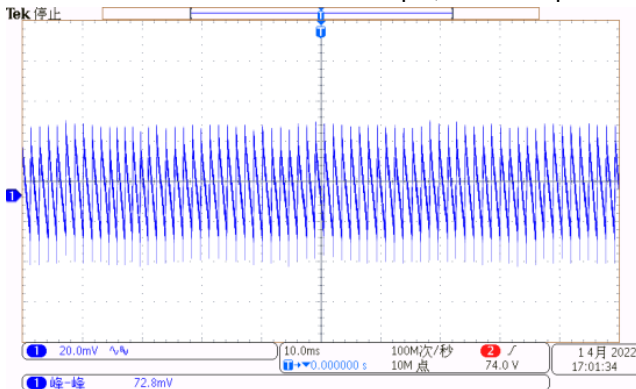

(CH1- Vripple)

Comments: Vripple=72.8mV

Test Condition: 230Vac/50Hz Input, 5V/3A Output

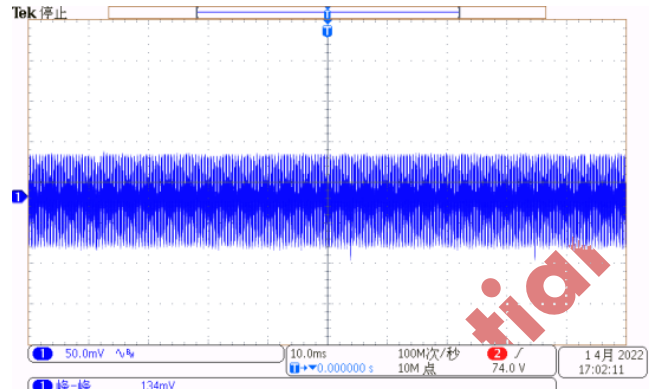

(CH1- Vripple)

Comments: Vripple=134mV

Test Condition: 230Vac/50Hz Input, 9V/0A Output

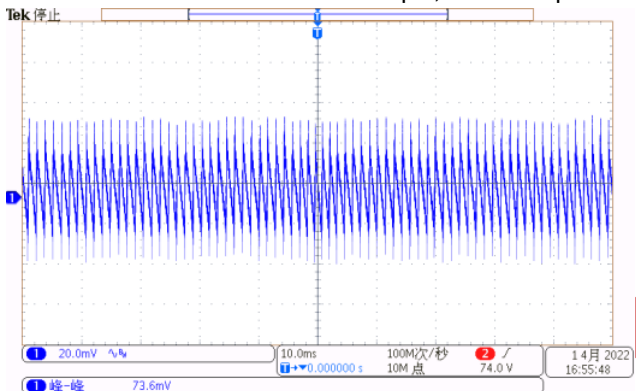

(CH1- Vripple)

Comments: Vripple=73.6mV

Test Condition: 230Vac/50Hz Input, 9V/3A Output

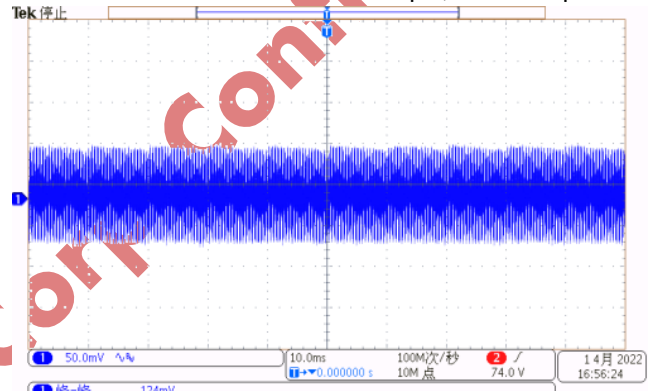

(CH1- Vripple)

Comments: Vripple=124mV

Test Condition: 230Vac/50Hz Input, 11V/0A Output

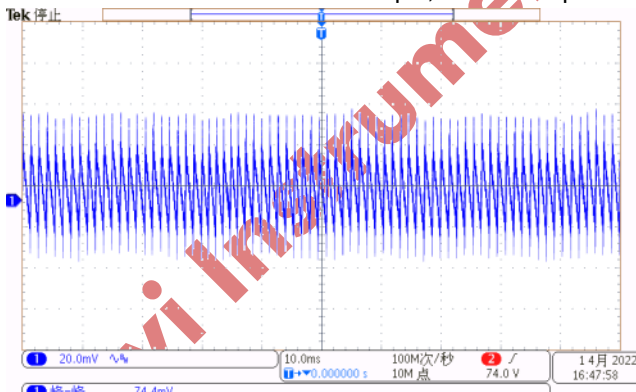

(CH1- Vripple)

Comments: Vripple=74.4mV

Test Condition: 230Vac/50Hz Input, 11V/3A Output

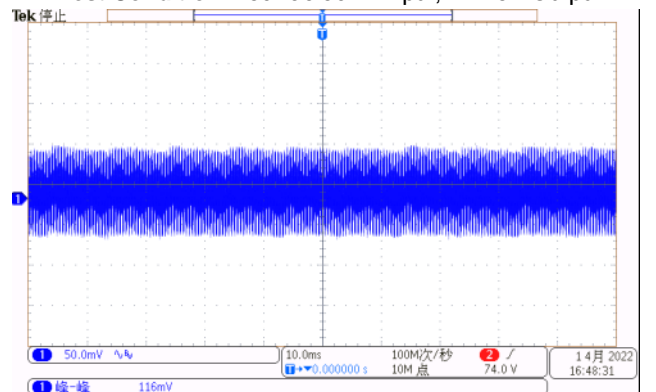

(CH1- Vripple)

Comments: Vripple=116mV



Test Condition: 230Vac/50Hz Input, 12V/0A Output

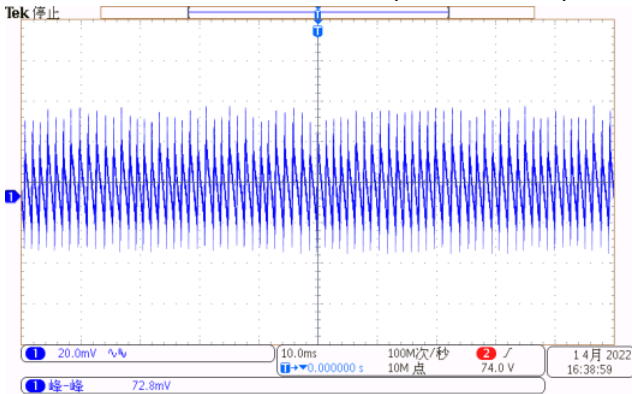

(CH1- Vripple)

Comments: Vripple=72.8mV

Test Condition: 230Vac/50Hz Input, 12V/2.5A Output

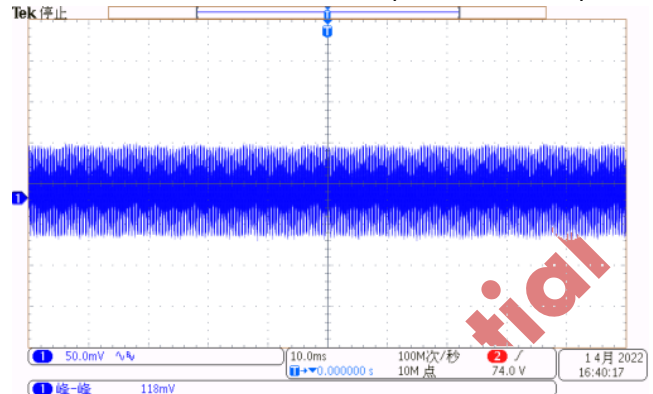

(CH1- Vripple)

Comments: Vripple=118mV

Test Condition: 230Vac/50Hz Input, 15V/0A Output

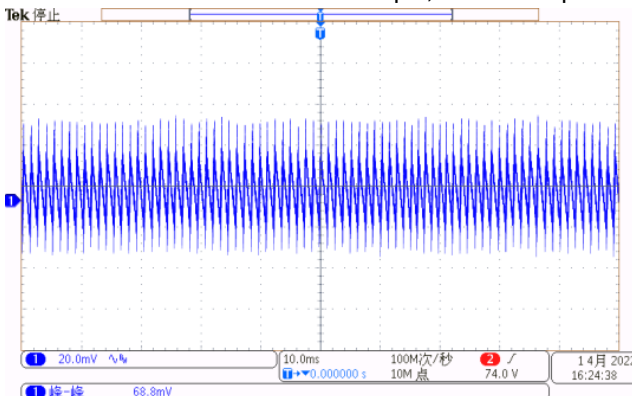

(CH1- Vripple)

Comments: Vripple=68.8mV

Test Condition: 230Vac/50Hz Input, 15V/2A Output

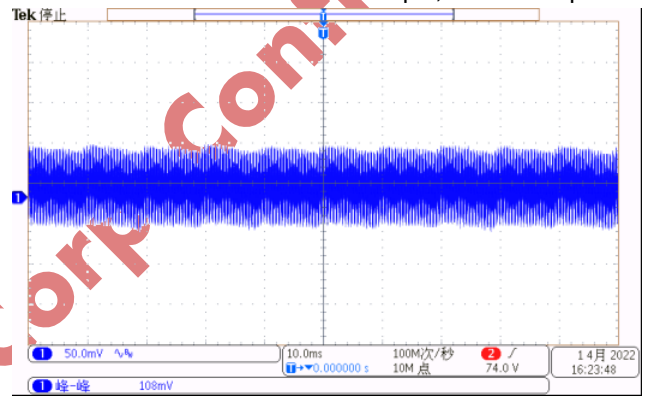

(CH1- Vripple)

Comments: Vripple=108mV

Test Condition: 230Vac/50Hz Input, 20V/0A Output

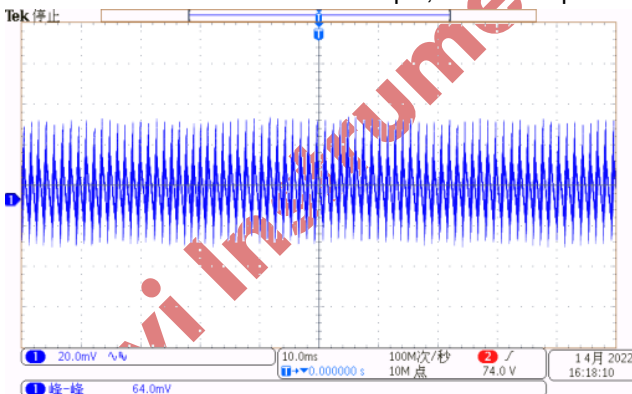

(CH1- Vripple)

Comments: Vripple=64mV

Test Condition: 230Vac/50Hz Input, 20V/1.5A Output

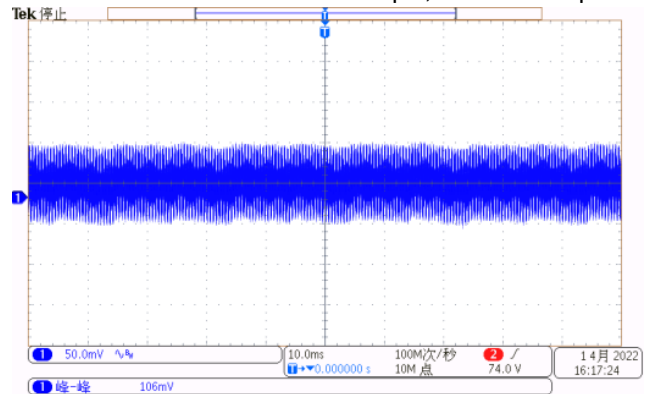

(CH1- Vripple)

Comments: Vripple=106mV



Demo Board Test Report
33W High Performance PD3.0 Charger
with Power Switch KP22062 and Synchronous Rectifier KP40611

Test Condition: 265Vac/50Hz Input, 5V/0A Output

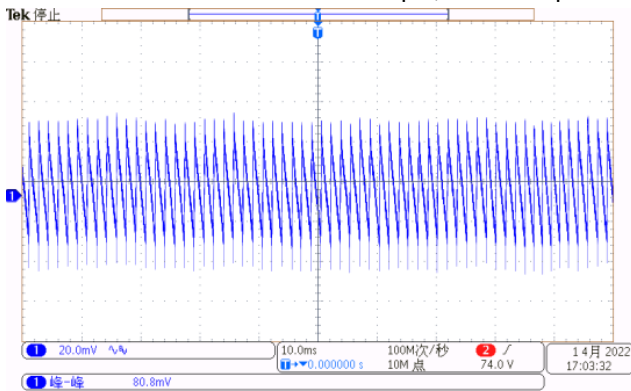

(CH1- Ripple)

Comments: Vripple=80.8mV

Test Condition: 265Vac/50Hz Input, 5V/3A Output

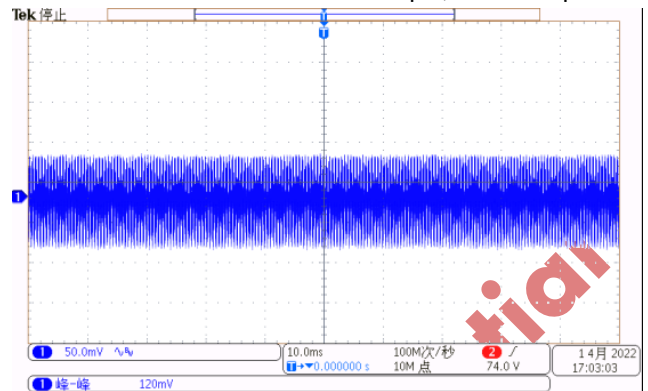

(CH1- Ripple)

Comments: Vripple=120mV

Test Condition: 265Vac/50Hz Input, 9V/0A Output

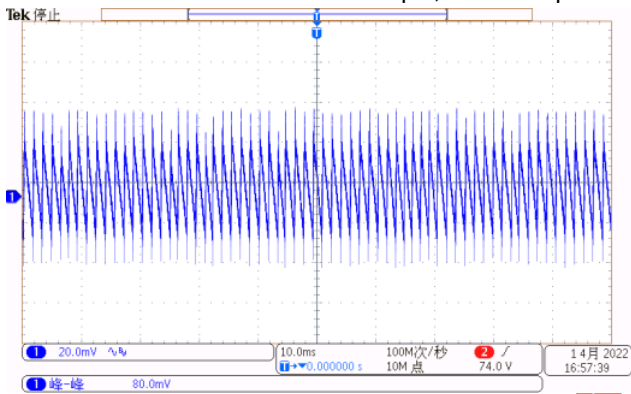

(CH1- Ripple)

Comments: Vripple=80mV

Test Condition: 265Vac/50Hz Input, 9V/3A Output

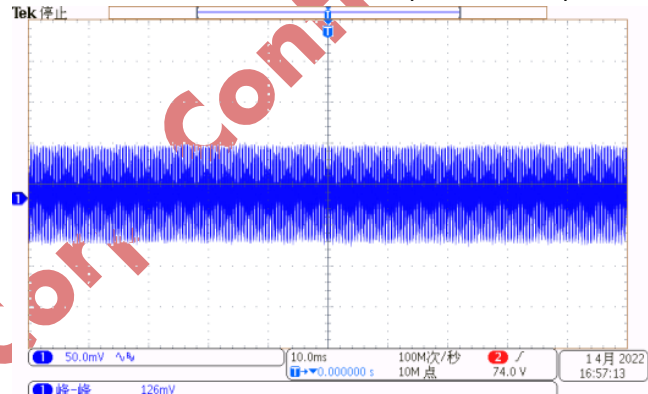

(CH1- Ripple)

Comments: Vripple=126mV

Test Condition: 265Vac/50Hz Input, 11V/0A Output

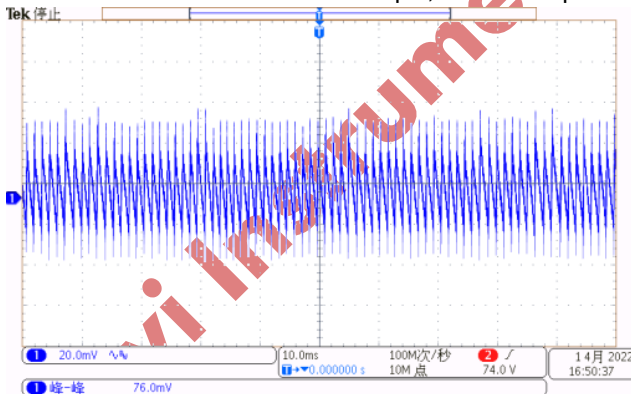

(CH1- Ripple)

Comments: Vripple=76mV

Test Condition: 265Vac/50Hz Input, 11V/3A Output

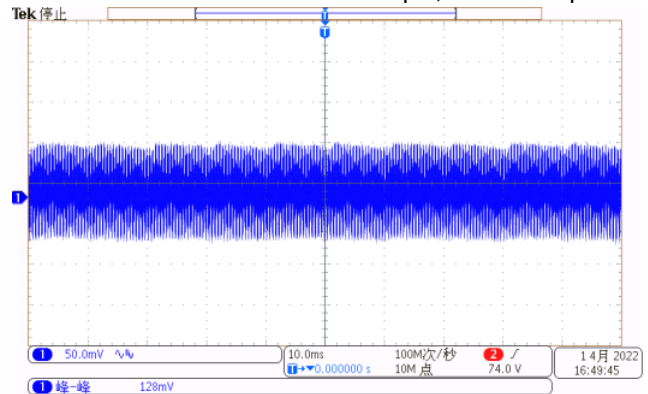

(CH1- Ripple)

Comments: Vripple=128mV



33W High Performance PD3.0 Charger
with Power Switch KP22062 and Synchronous Rectifier KP40611

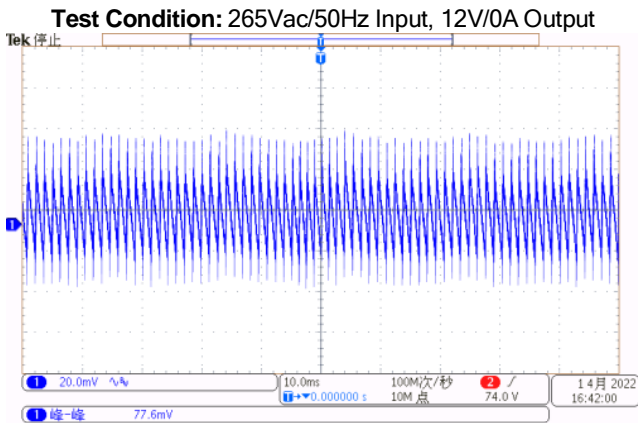

(CH1- Ripple)
Comments: Vripple=77.6mV

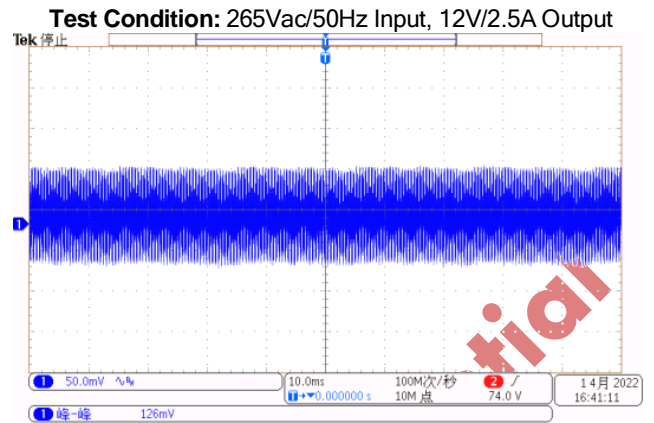

(CH1- Ripple)
Comments: Vripple=126mV

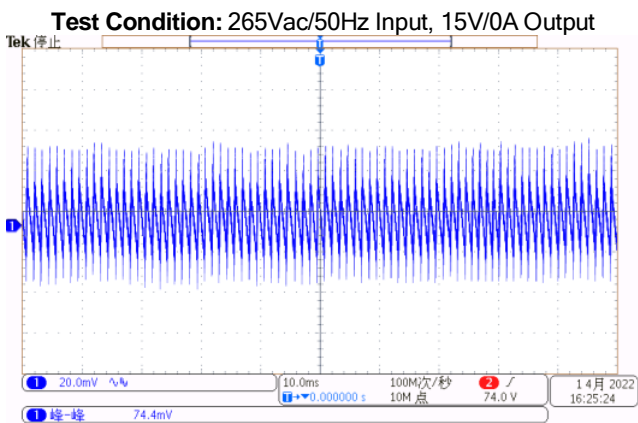

(CH1- Ripple)
Comments: Vripple=74.4mV

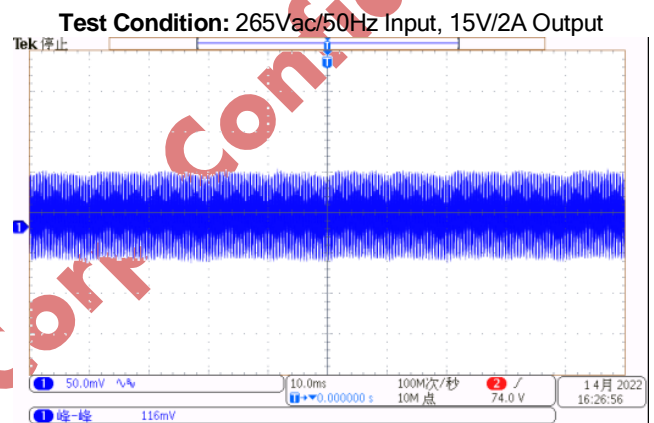

(CH1- Ripple)
Comments: Vripple=116mV

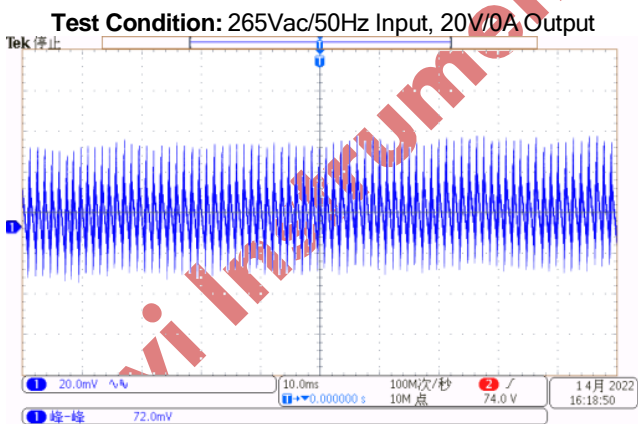

(CH1- Ripple)
Comments: Vripple=72mV

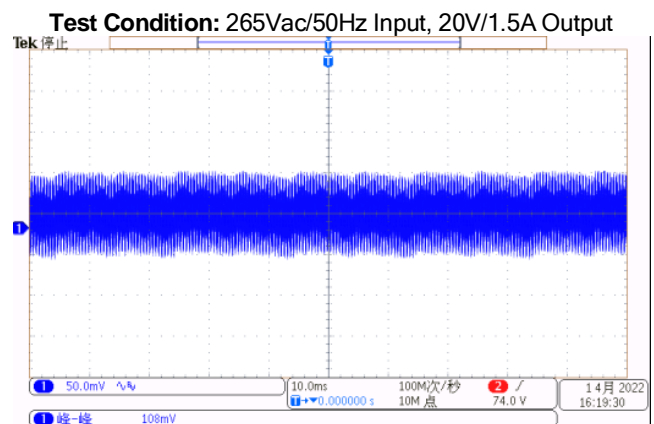

(CH1- Ripple)
Comments: Vripple=108mV

2.3 Load Transient Test

Standard: Under the input voltage 90Vac~265Vac, the output voltage transient response should be within $\pm 10\%$ normal voltage.

Result: Pass

Note: 10% load shift to 90% load with 0.25A/ μ s changing ramp and 100Hz changing frequency.

Input Voltage	Output Voltage(V)											
	5V		9V		11V		12V		15V		20V	
	Vo-min	Vo-max	Vo-min	Vo-max	Vo-min	Vo-max	Vo-min	Vo-max	Vo-min	Vo-max	Vo-min	Vo-max
115Vac/60Hz	4.88	5.4	8.74	9.48	10.78	11.44	11.84	12.44	14.94	15.46	20.06	20.58
230Vac/50Hz	4.84	5.46	8.72	9.42	10.82	11.44	11.86	12.46	14.96	15.48	20.04	20.58

Waveforms:

Test Condition: Load 5V/(0.3-2.7)A, frequency 100Hz, duty Cycle=50%, slew rate=0.25A/ μ s

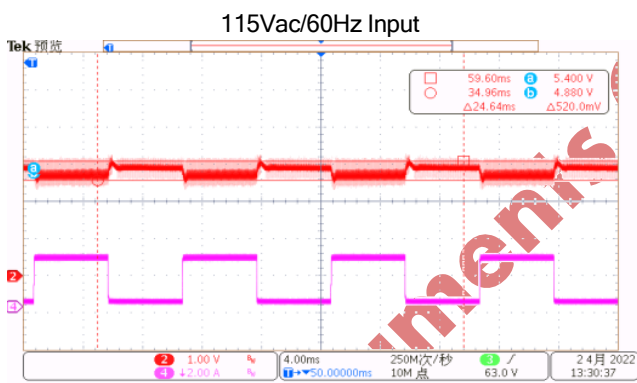

(CH2-Vo, CH4-Io)

Comments: Vo-min/max=4.88V/5.4V

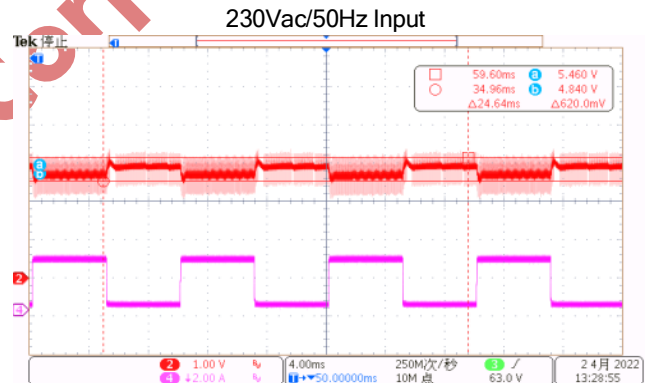

(CH2-Vo, CH4-Io)

Comments: Vo-min/max=4.84V/5.46V

Test Condition: Load 9V/(0.3-2.7)A, frequency 100Hz, duty Cycle=50%, slew rate=0.25A/ μ s

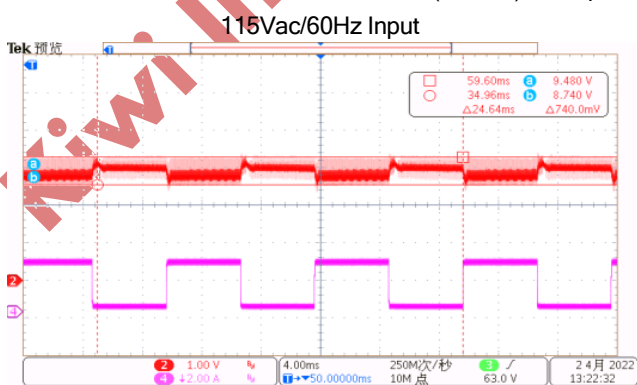

(CH2-Vo, CH4-Io)

Comments: Vo-min/max=8.78V/9.48V

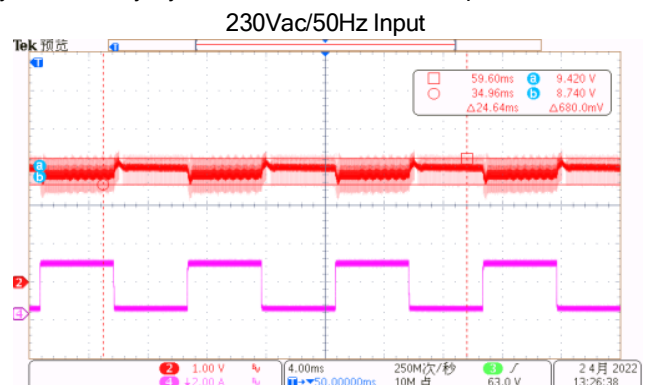

(CH2-Vo, CH4-Io)

Comments: Vo-min/max=8.74V/9.42V

33W High Performance PD3.0 Charger
with Power Switch KP22062 and Synchronous Rectifier KP40611

Test Condition: Load 11V/(0.3-2.7)A, frequency 100Hz, duty Cycle=50%, slew rate=0.25A/ μ s

115Vac/60Hz Input

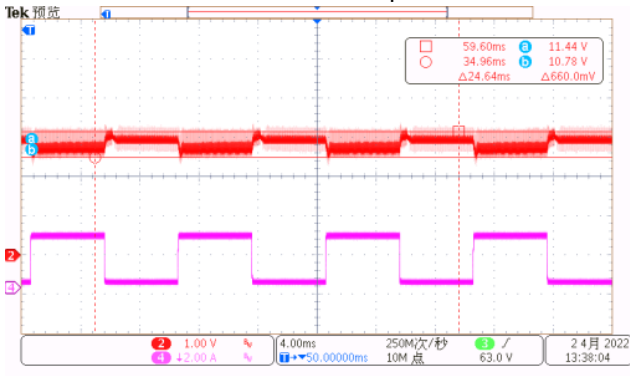

(CH2-Vo, CH4-Io)

Comments: Vo-min/max=10.78V/11.44V

230Vac/50Hz Input

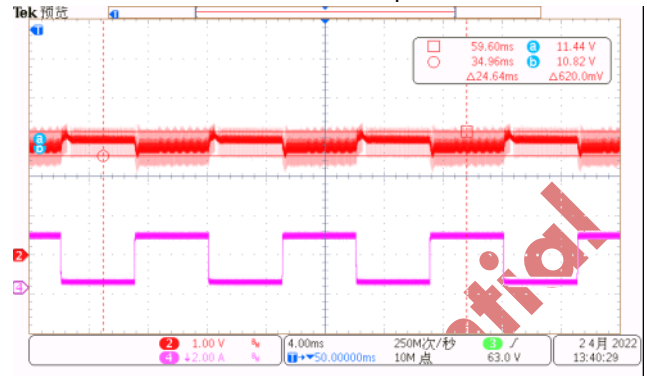

(CH2-Vo, CH4-Io)

Comments: Vo-min/max=11.82V/11.44V

Test Condition: Load 12V/(0.25-2.25)A, frequency 100Hz, duty Cycle=50%, slew rate=0.25A/ μ s

115Vac/60Hz Input

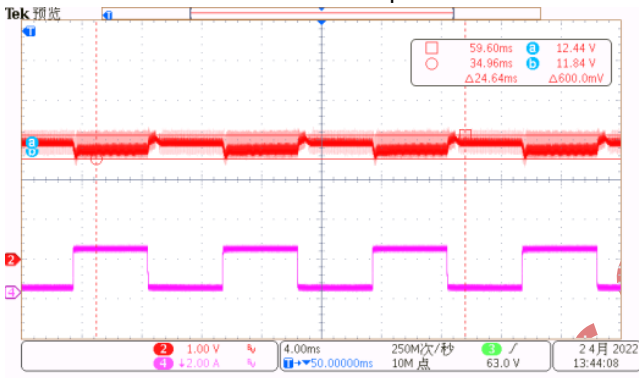

(CH2-Vo, CH4-Io)

Comments: Vo-min/max=11.84V/12.44V

230Vac/50Hz Input



(CH2-Vo, CH4-Io)

Comments: Vo-min/max=11.86V/12.46V

Test Condition: Load 15V/(0.2-1.8)A, frequency 100Hz, duty Cycle=50%, slew rate=0.25A/ μ s

115Vac/60Hz Input



(CH2-Vo, CH4-Io)

Comments: Vo-min/max=14.96V/15.48V

230Vac/50Hz Input

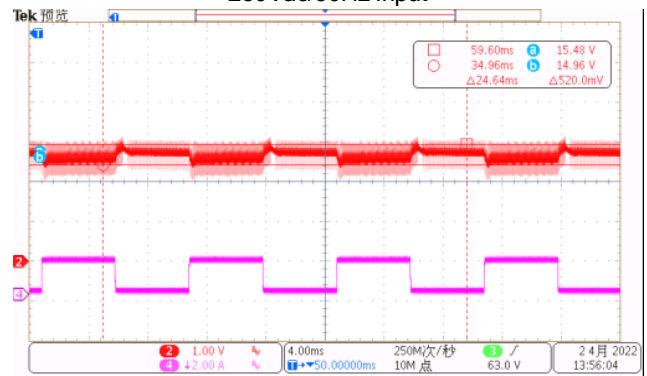

(CH2-Vo, CH4-Io)

Comments: Vo-min/max=14.96V/15.48V

Test Condition: Load 20V/(0.15-1.35)A, frequency 100Hz, duty Cycle=50%, slew rate=0.25A/μs

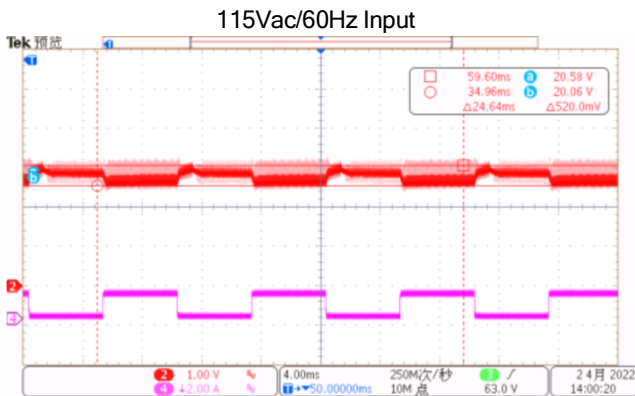

(CH2-Vo, CH4-Io)

Comments: Vo-min/max=20.06V/20.58V

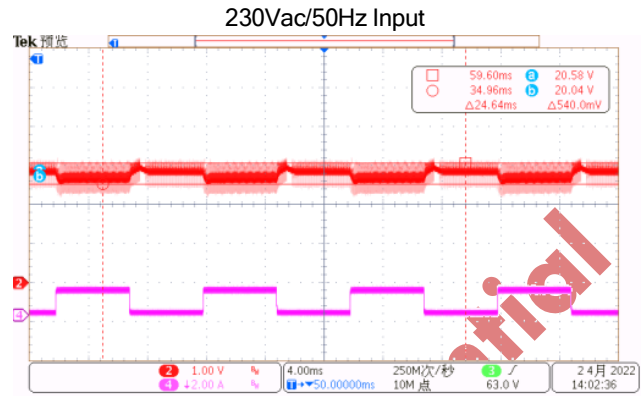

(CH2-Vo, CH4-Io)

Comments: Vo-min/max=20.04V/20.58V

2.4 Capacitive Load Startup Test

Standard: While capacitance load is 3000uF, the power supply can turn on normally and the output is in the rated range.

Result: Pass

Note: Tested at the output cap end@5V/3A.

Waveforms:

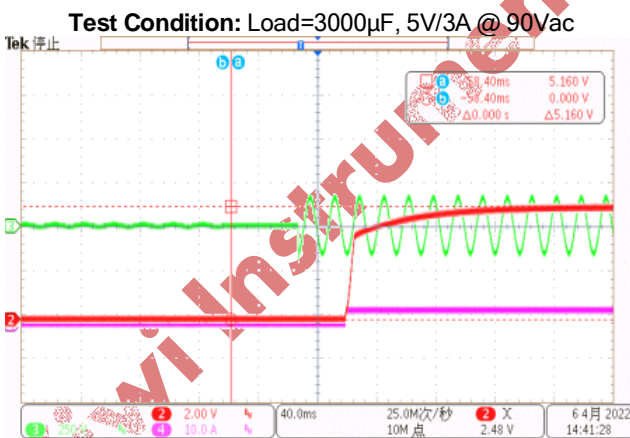

(CH2-Vo, CH3-Vinac, CH4-Io)

Comments: Startup Normally

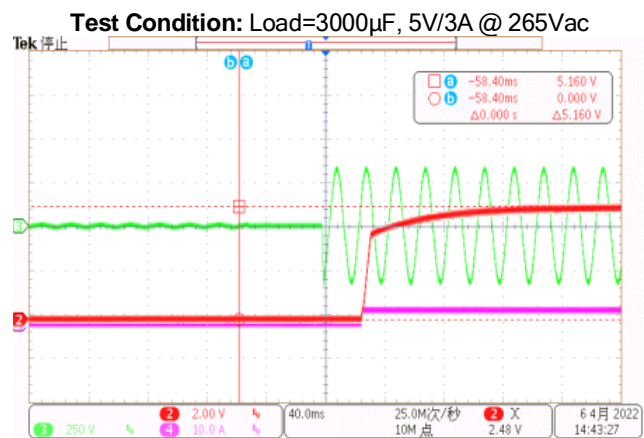

(CH2-Vo, CH3-Vinac, CH4-Io)

Comments: Startup Normally



2.5 Startup Time and Raise Time

Standard: The startup time should be less than 3s@90Vac.

Result: Pass

Note: The output voltage is tested at the output cap end.

Test Data:

Input Voltage	90Vac/60Hz	115Vac/60Hz	230Vac/50Hz	265Vac/50Hz
Startup Time(mS)	94.2	90.6	78.4	73.6

Input Voltage	90Vac/60Hz		115Vac/60Hz		230Vac/50Hz		265Vac/50Hz	
	5V/0A	5V/3A	5V/0A	5V/3A	5V/0A	5V/3A	5V/0A	5V/3A
Rrise Time(mS)	29	30	28.6	29.8	28.4	29.6	28.6	29.8

Waveforms:

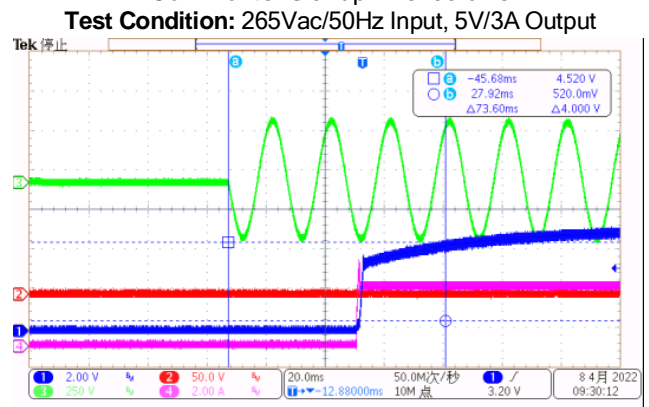
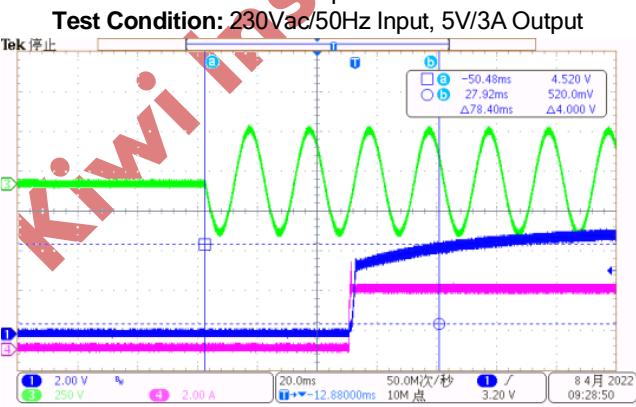
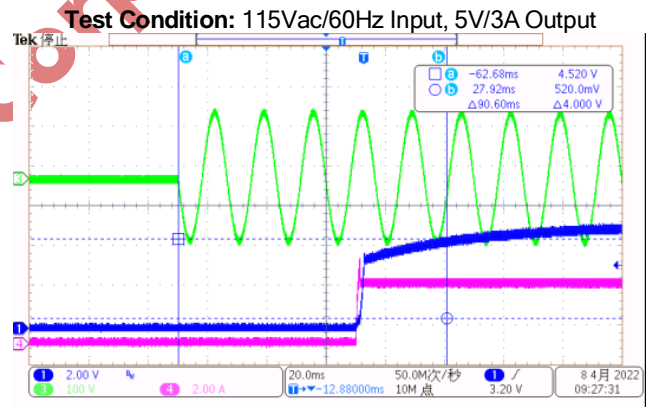
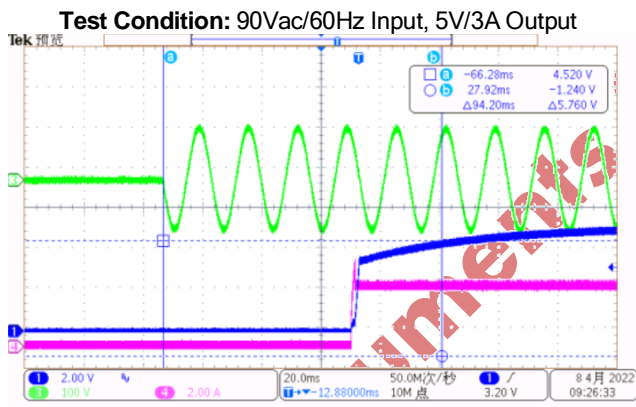

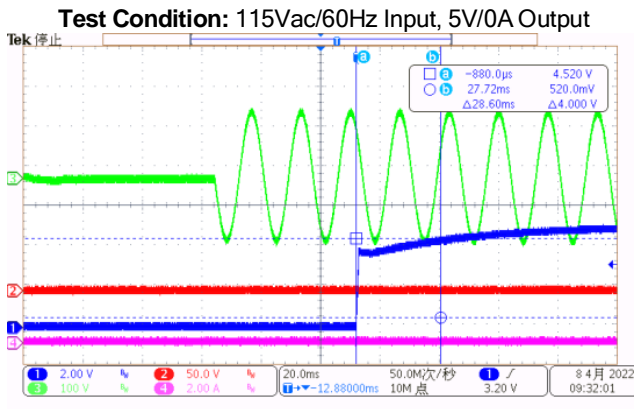

(CH1-Vo, CH3-Vinac, CH4-Io)
Comments: Raise time=28.6ms

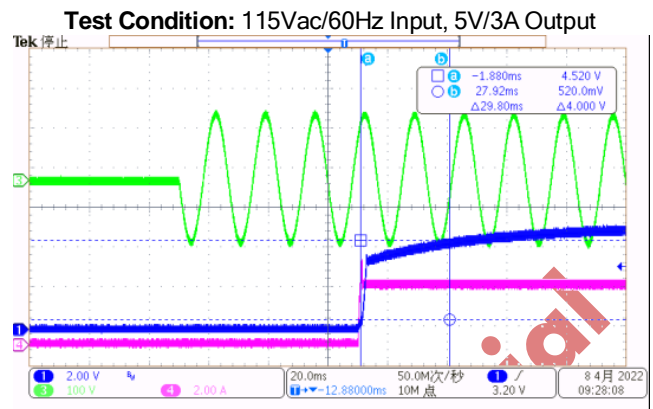

(CH1-Vo, CH3-Vinac, CH4-Io)
Comments: Raise time=29.8ms

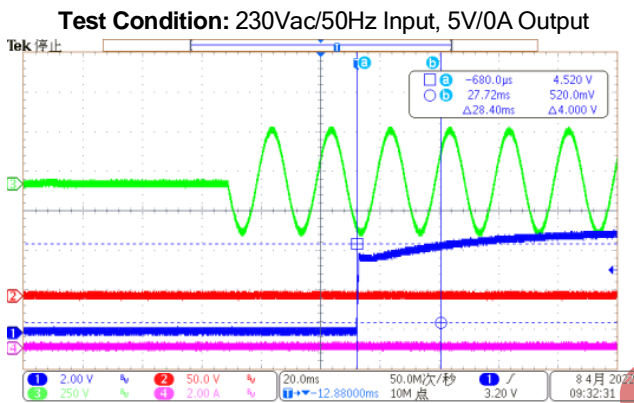

(CH1-Vo, CH3-Vinac, CH4-Io)
Comments: Raise time=28.4ms

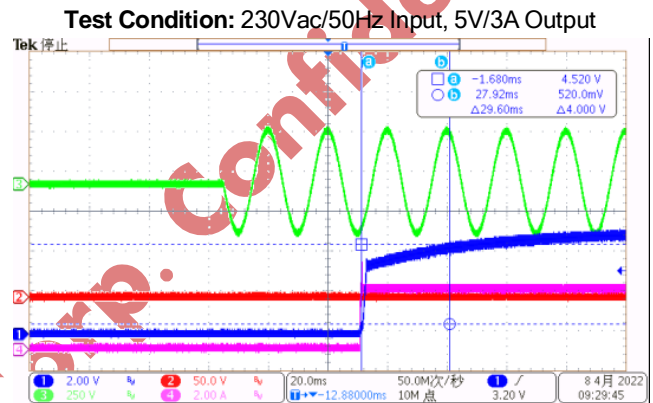

(CH1-Vo, CH3-Vinac, CH4-Io)
Comments: Raise time=29.6ms

2.6 Holdup Time and Fall Time

Standard: The holdup time should be larger than 10ms@115/230Vac.

Result: Pass

Note: The output voltage is tested at the output cap end.

Input Voltage	Holdup time(mS)					
	5V/3A	9V/3A	11V/3A	12V/2.5A	15V/2A	20V/1.5A
115Vac/60Hz	30.1	14.6	11.5	13.7	14.1	14.5
230Vac/50Hz	122.6	76.8	62.2	69.4	70	70.4
Result	PASS	PASS	PASS	PASS	PASS	PASS
Input Voltage	Fall time (mS)					
	5V/3A	9V/3A	11V/3A	12V/2.5A	15V/2A	20V/1.5A
115Vac/60Hz	2.5	3.9	4.2	4.2	5.6	9
230Vac/50Hz	1.4	3.6	4.2	4.4	6	9.2
Result	PASS	PASS	PASS	PASS	PASS	PASS

Waveforms:

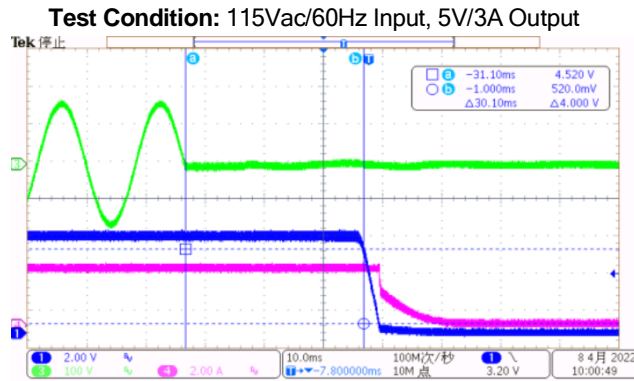

(CH1-Vo, CH3-Vinac, CH4-Io)
Comments: Holdup time=30.1ms

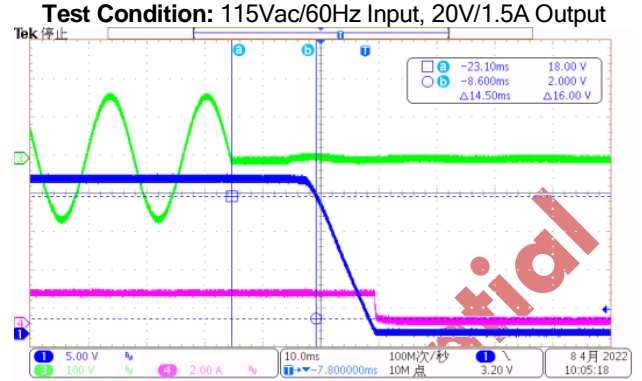

(CH1-Vo, CH3-Vinac, CH4-Io)
Comments: Holdup time=14.5ms

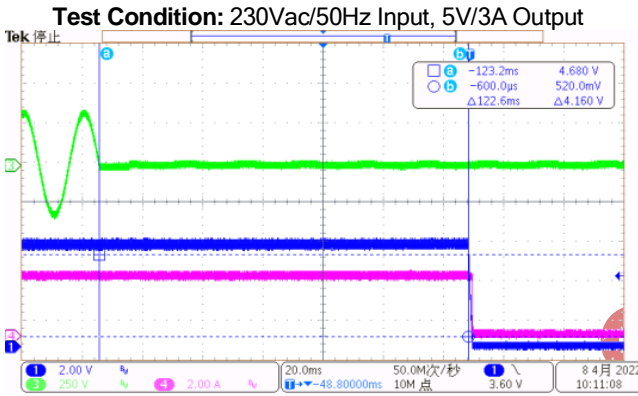

(CH1-Vo, CH3-Vinac, CH4-Io)
Comments: Comments: Holdup time=122.6ms

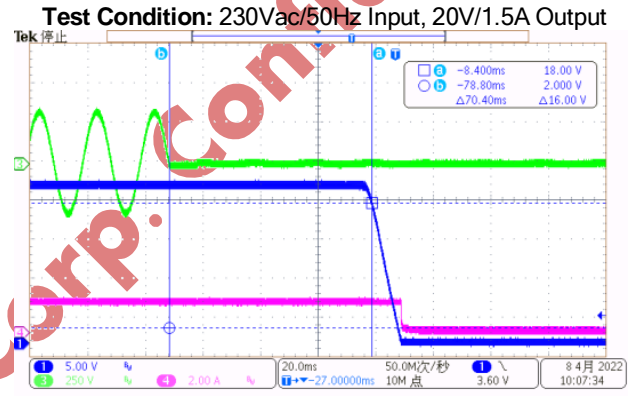

(CH1-Vo, CH3-Vinac, CH4-Io)
Comments: Comments: Holdup time=70.4ms

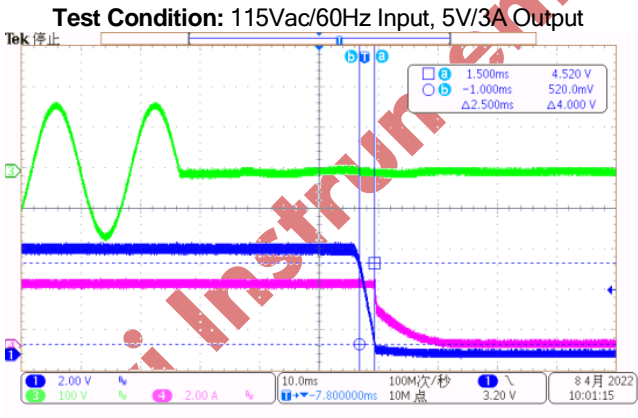

(CH1-Vo, CH3-Vinac, CH4-Io)
Comments: Comments: Fall time=2.5ms

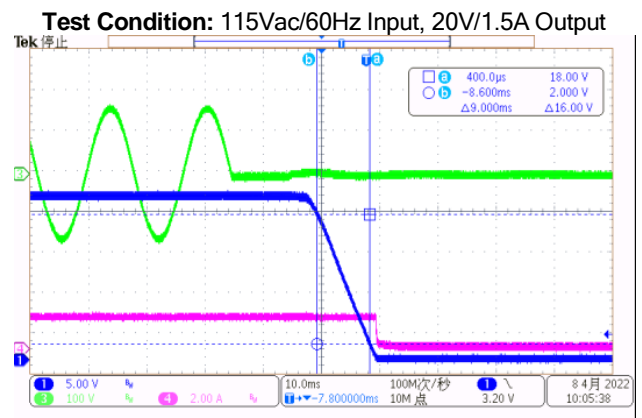

(CH1-Vo, CH3-Vinac, CH4-Io)
Comments: Comments: Fall time=9ms

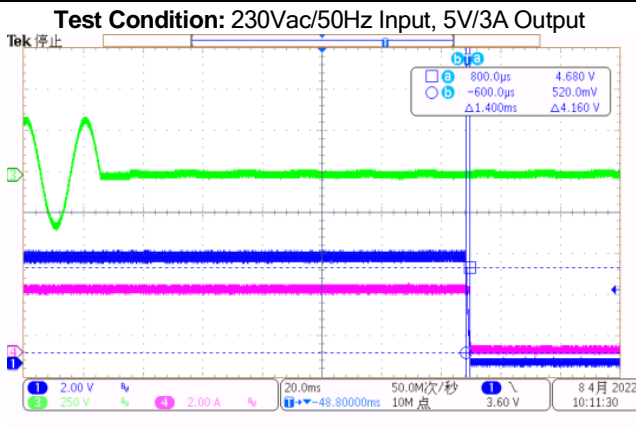

(CH1-Vo, CH3-Vinac, CH4-Io)
Comments: Comments: Fall time=1.4ms

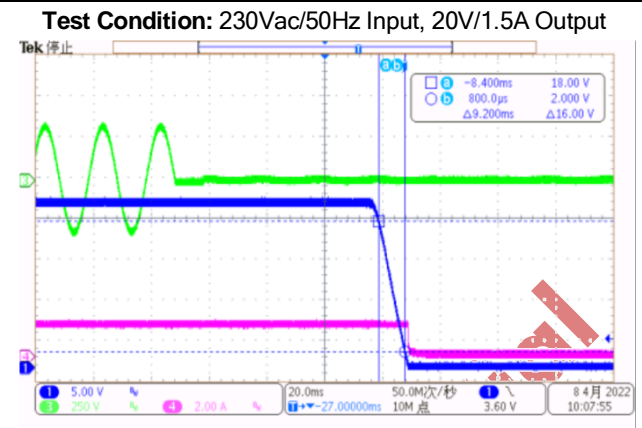

(CH1-Vo, CH3-Vinac, CH4-Io)
Comments: Comments: Fall time=9.2ms

2.7 Output Overshoot Test

Standard: $V_{o-peak} < \text{output voltage} * 110\%$.

Result: Pass

Note: The output voltage is tested at the output cap end.

Test Data:

	90V/60Hz		115V/60Hz		230V/50Hz		265V/50Hz	
	5V/0A	5V/3A	5V/0A	5V/3A	5V/0A	5V/3A	5V/0A	5V/3A
Vo-peak(V)	5.2	5.2	5.24	5.24	5.24	5.2	5.24	5.2

Waveforms:

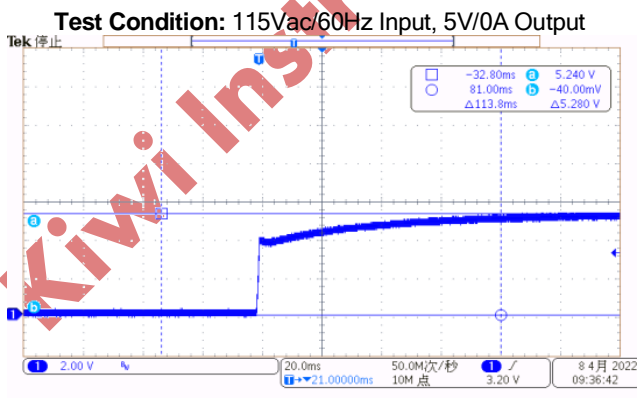

(CH1- Vo)
Comments: Vo-peak=5.24V

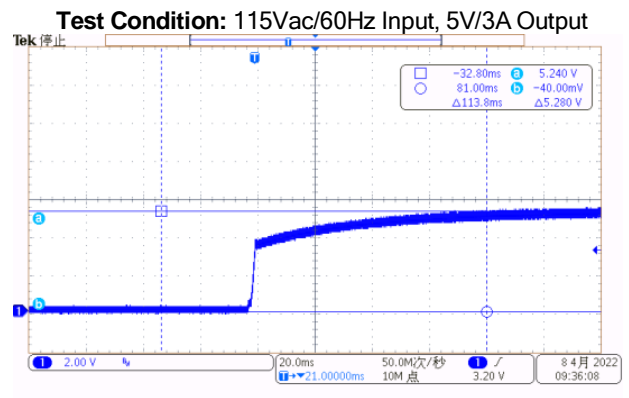

(CH1- Vo)
Comments: Vo-peak=5.24V

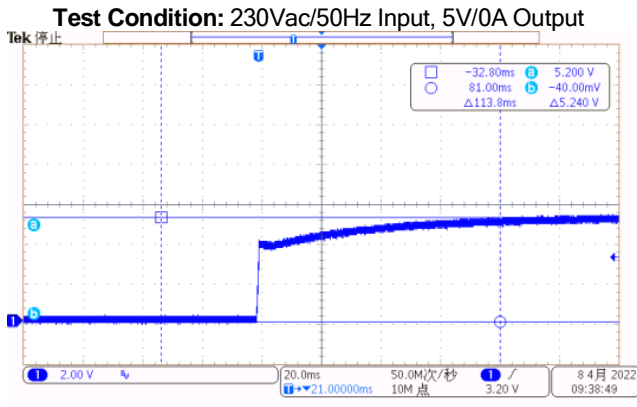

(CH1- Vo)
Comments: Vo-peak=5.2V

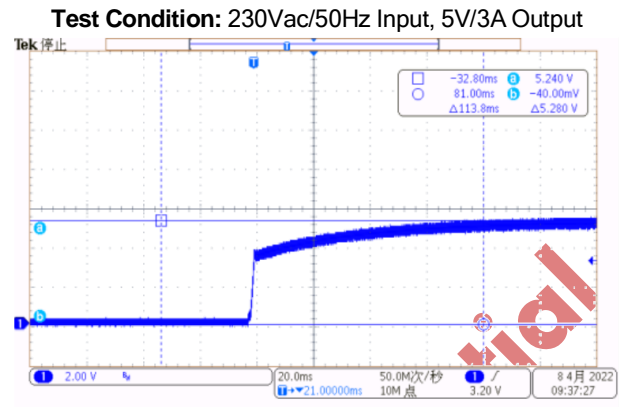

(CH1- Vo)
Comments: Vo-peak=5.24V

3 Protection Test

3.1 Short Circuit Protection

Standard: The power supply must shut down in the event of short-circuit condition and automatically return to normal operating condition once the fault condition has been removed. And the peak input power should be less than 5W.

Result: Pass

Note: The short circuit protection is tested at the output cap end.

Test Data:

Input Voltage (Vac)	90V/60Hz	115V/60Hz	230V/50Hz	265V/50Hz	Result
Pin(W)	2.7	2.76	2.31	2.36	PASS

Waveforms:

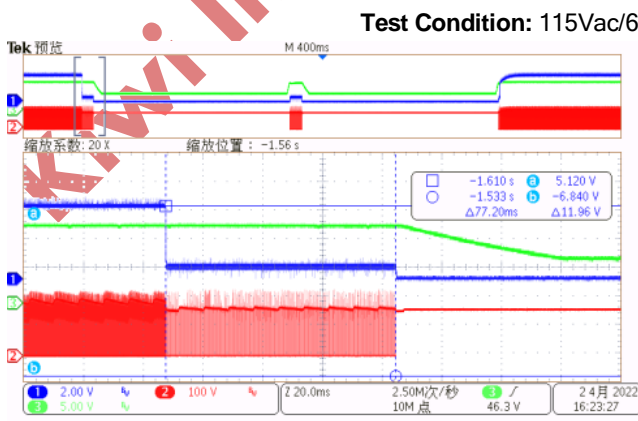

(CH1-Vo, CH2-VDrain, CH3-VDDL)
Comments: Protection enter

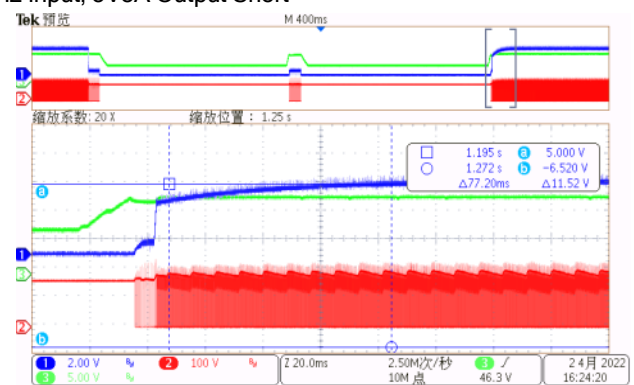

(CH1-Vo, CH2-VDrain, CH3-VDDL)
Comments: Recover to 5V

Test Condition: 115Vac/60Hz Input, 20V1.5A Output Short



(CH1-Vo, CH2-VDrain, CH3-VDDL)
Comments: Protection enter



(CH1-Vo, CH2-VDrain, CH3-VDDL)
Comments: Recover to 5V

Test Condition: 230Vac/50Hz Input, 5V3A Output Short

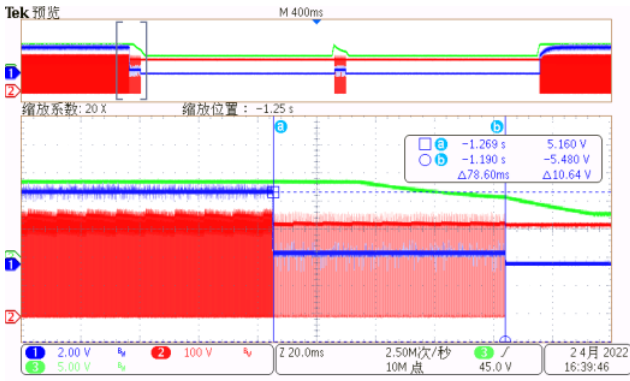

(CH1-Vo, CH2-VDrain, CH3-VDDL)
Comments: Protection enter

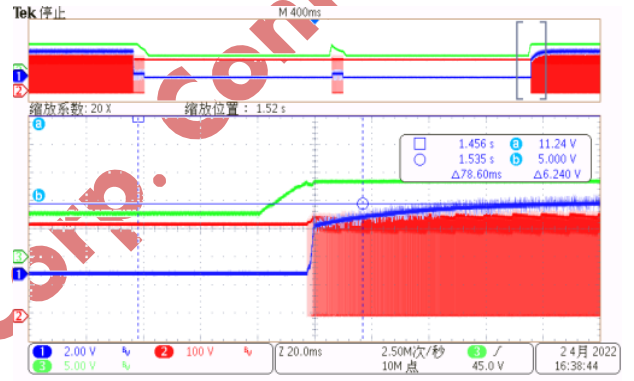

(CH1-Vo, CH2-VDrain, CH3-VDDL)
Comments: Recover to 5V

Test Condition: 230Vac/50Hz Input, 20V1.5A Output Short

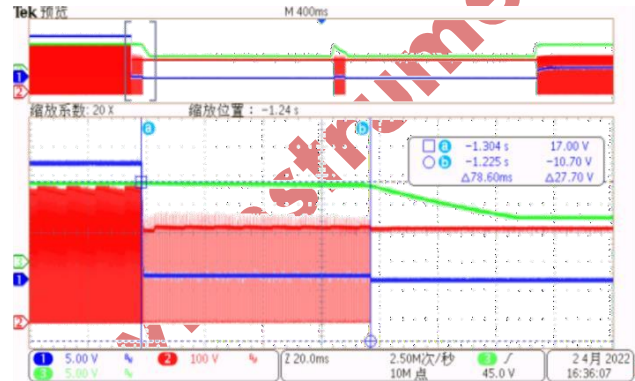

(CH1-Vo, CH2-VDrain, CH3-VDDL)
Comments: Protection enter

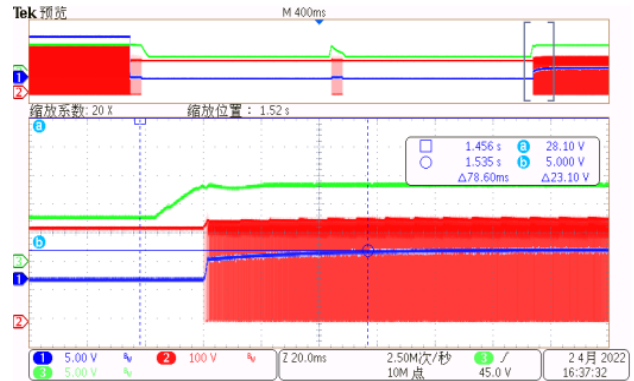

(CH1-Vo, CH2-VDrain, CH3-VDDL)
Comments: Recover to 5V

3.2 Over Current Protection

Standard: The overload current should be larger than 110% of full load current and meet LPS requirements.

Result: Pass

Note: Tested at the output cap end.

Test Data:

Input Voltage	OCP (A)					
	5V	9V	11V	12V	15V	20V
90Vac/60Hz	4.02	3.75	3.4	3.27	2.62	2.41
115Vac/60Hz	4.09	3.98	3.87	3.75	2.65	2.61
230Vac/50Hz	4.13	4.09	4.09	4.09	2.7	2.61
264Vac/50Hz	4.21	4.15	4.1	4.09	2.76	2.71

3.3 Input Brown-out Protection

Standard: The power supply should shut down when the input voltage is lower than the Brown-out protection value and return to normal operating condition when the input in the range of normal operating voltage

Result: Pass

Waveforms:

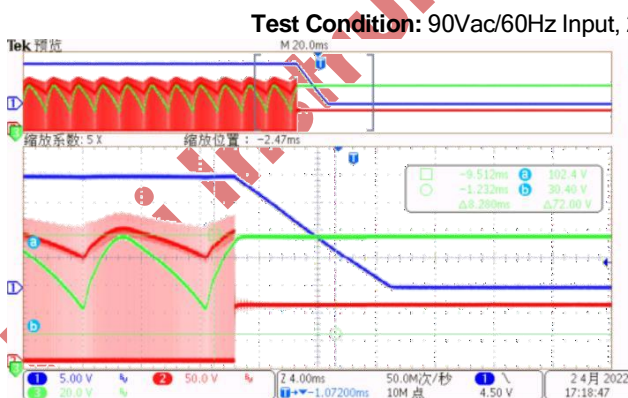

Comments: 102.4Vdc(72Vac) Protection enter

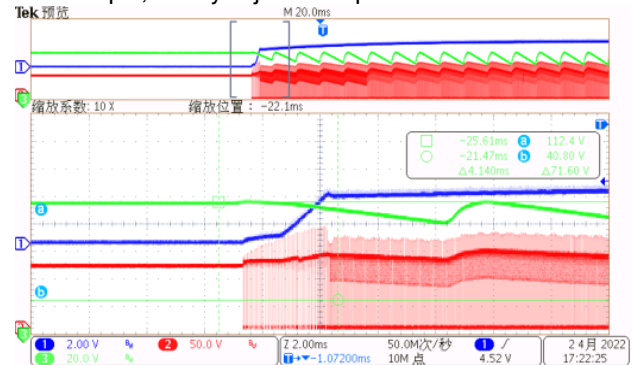

Comments: 112.4Vdc (80Vac) Protection recovery

4 Reliability Requirements

4.1 Device Maximum Rating Test

Standard: MOSFET and Diode<95% Rating

Result: Pass

Component	Rating	265Vac/50Hz			Result
		5V/3A	20V/1.5A		
		Startup	Steady	Short	
KP22062	650V	454V	538V	542V	PASS
KP40611	100V	74V	76.4V	86.8V	PASS

Waveforms:

Test Condition: 265Vac/50Hz Input, 5V3A Output, Startup

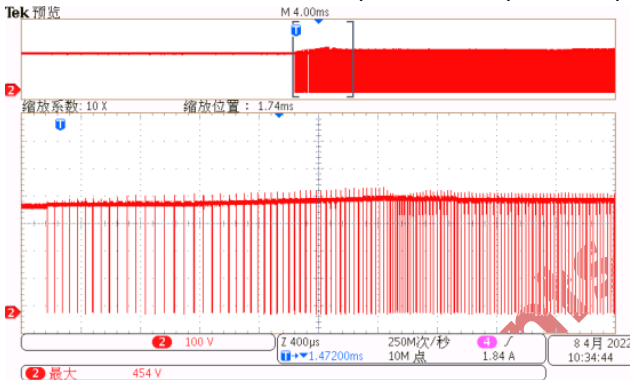

(CH2-VDrain)

Comments: VDrain_peak=454V

Test Condition: 265Vac/50Hz Input, 20V1.5A Output, Steady

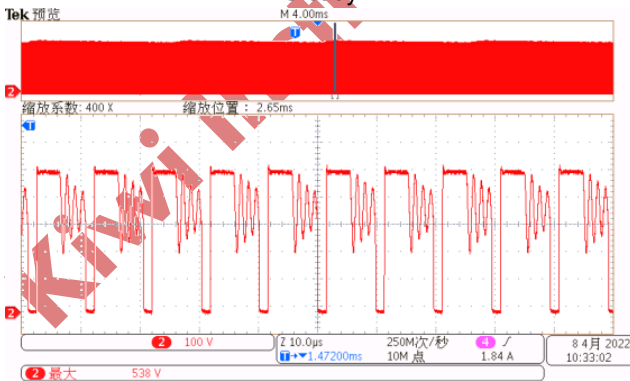

(CH2-VDrain)

Comments: VDrain_peak=538V

Test Condition: 265Vac/50Hz Input, 5V3A Output, Startup

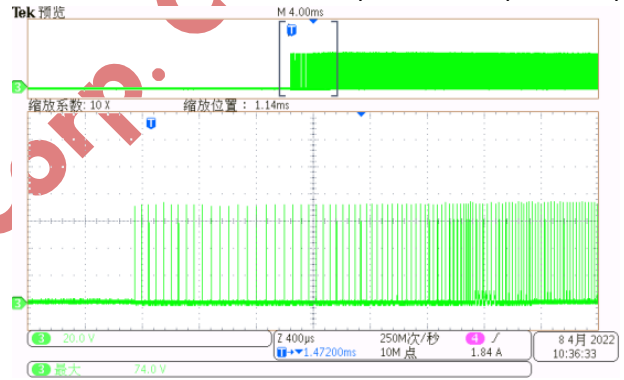

((CH3-VSR))

Comments: VSR_peak=74V

Test Condition: 265Vac/50Hz Input, 20V1.5A Output, Steady

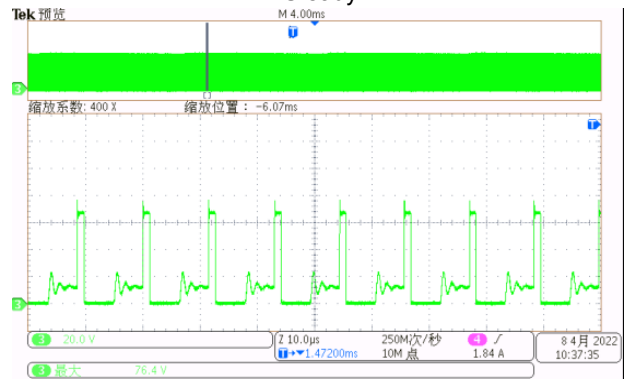

((CH3-VSR))

Comments: VSR_peak=76.4V

Test Condition: 265Vac/50Hz Input, 20V1.5A Output, Short

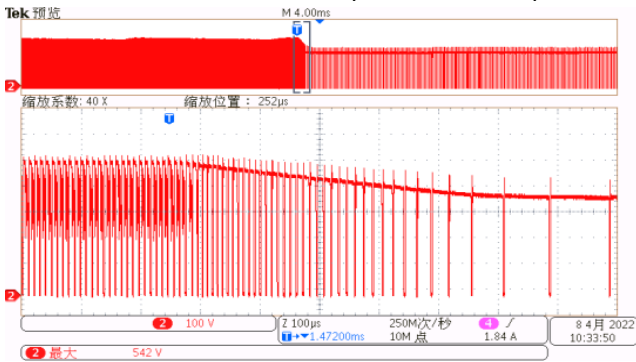

(CH2-VDrain)

Comments: VDrain_peak=542V

Test Condition: 265Vac/50Hz Input, 20V1.5A Output, Short

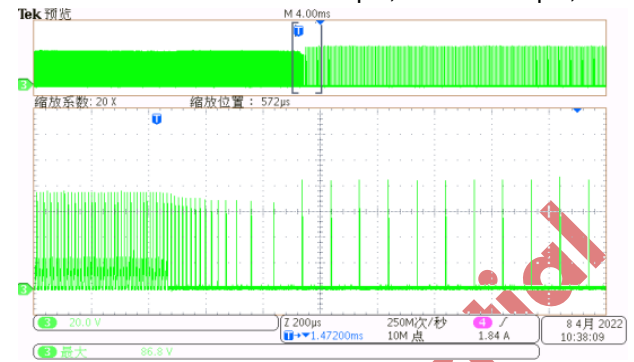

((CH3-VSR))

Comments: VSR_peak=86.8V

4.2 Bmax Test

Standard: Steady-state rated load: Bmax≤0.32T;

Transient and its peak load: Bmax≤0.38T.

Result: Pass

Note: The turn numbers of the transform is 48, and the sectional area is 48mm², Lp is 420μH, Rcs=0.36R.

Bmax(T)	90Vac/60Hz						Bmax_Limit(T)	Result
	5V	9V	11V	12V	15V	20V		
Steady	0.22	0.265	0.307	0.269	0.249	0.224	0.32T	PASS
OverLoad	0.281	0.315	0.318	0.318	0.318	0.307	0.38T	PASS

Waveforms:

Test Condition: 90Vac/60Hz Input, 5V/3A Output, Steady

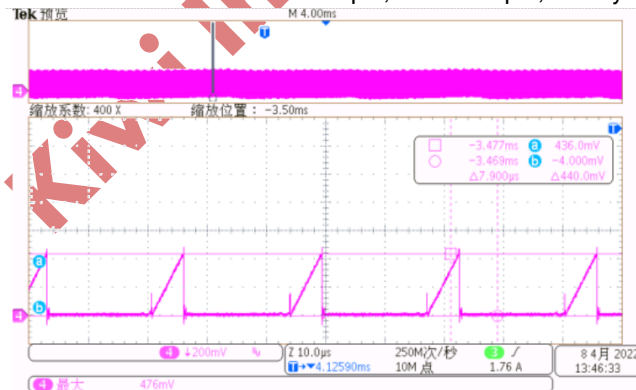

(CH4-Vcs)

Comments: Vcs=436mV, Rcs=0.36R, Ics=1.211A

Test Condition: 90Vac/60Hz Input, 5V Output, Overload

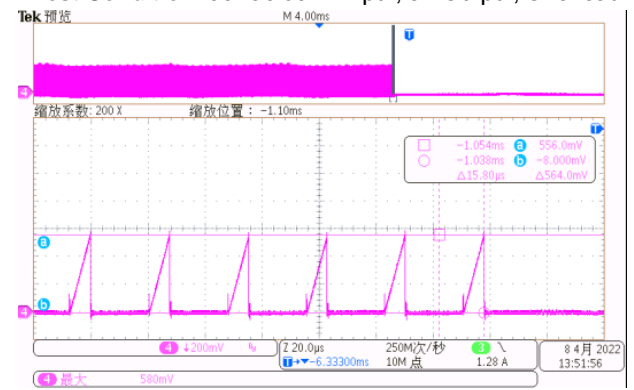

(CH4-Vcs)

Comments: Vcs=556mV, Rcs=0.36R, Ics=1.544A

33W High Performance PD3.0 Charger
with Power Switch KP22062 and Synchronous Rectifier KP40611

Test Condition: 90Vac/60Hz Input, 9V3A Output, Steady

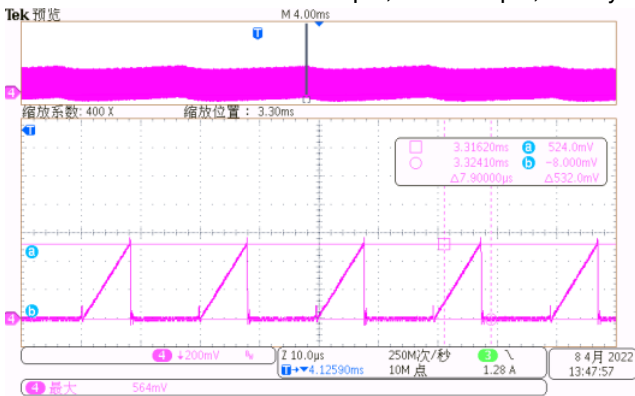

(CH4-Vcs)

Comments: Vcs=524mV, Rcs=0.36R, Ics=1.455A

Test Condition: 90Vac/60Hz Input, 9V Output, Overload

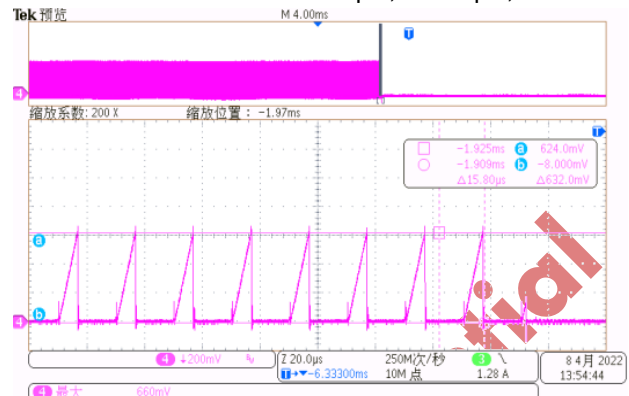

(CH4-Vcs)

Comments: Vcs=624mV, Rcs=0.36R, Ics=1.733A

Test Condition: 90Vac/60Hz Input, 11V3A Output, Steady

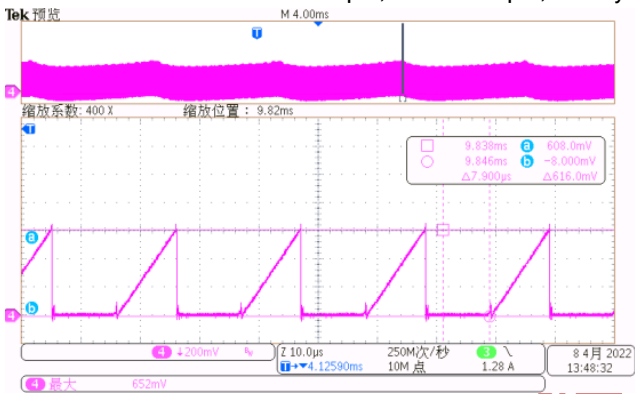

(CH4-Vcs)

Comments: Vcs=608mV, Rcs=0.36R, Ics=1.688A

Test Condition: 90Vac/60Hz Input, 11V Output, Overload

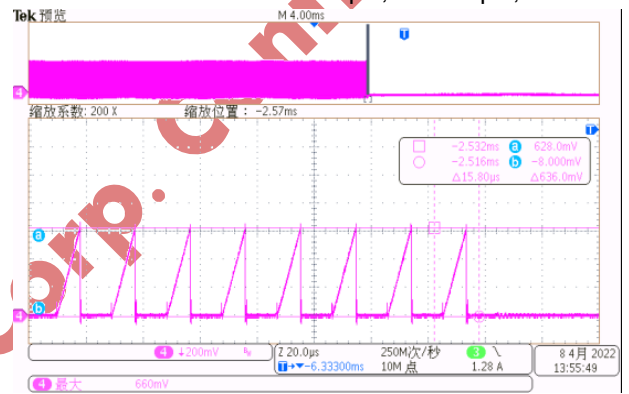

(CH4-Vcs)

Comments: Vcs=628mV, Rcs=Rcs=0.36R, Ics=1.744A

Test Condition: 90Vac/60Hz Input, 12V2.5A Output, Steady

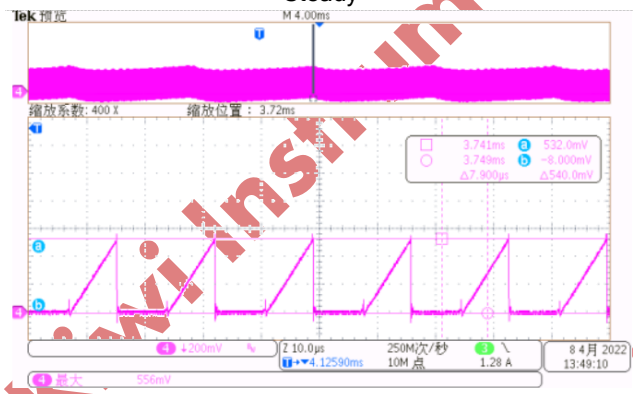

(CH4-Vcs)

Comments: Vcs=532mV, Rcs=0.36R, Ics=1.477A

Test Condition: 90Vac/60Hz Input, 12V Output, Overload

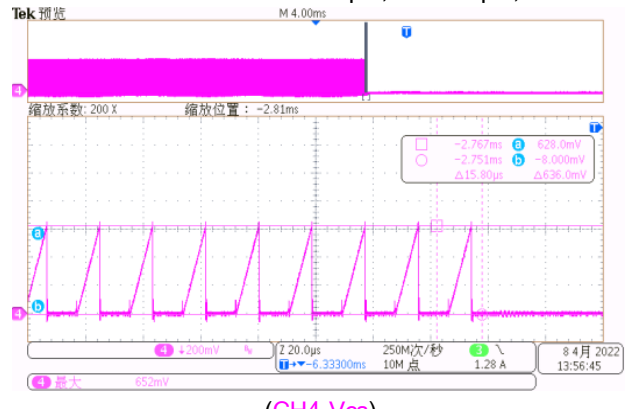

(CH4-Vcs)

Comments: Vcs=628mV, Rcs=0.36R, Ics=1.744A

33W High Performance PD3.0 Charger
with Power Switch KP22062 and Synchronous Rectifier KP40611

Test Condition: 90Vac/60Hz Input, 15V2A Output, Steady

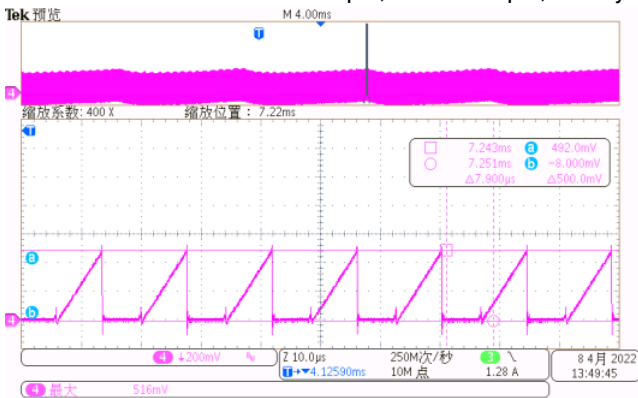

(CH4-Vcs)

Comments: Vcs=492mV, Rcs=0.36R, Ics=1.366A

Test Condition: 90Vac/60Hz Input, 20V1.5A Output, Steady

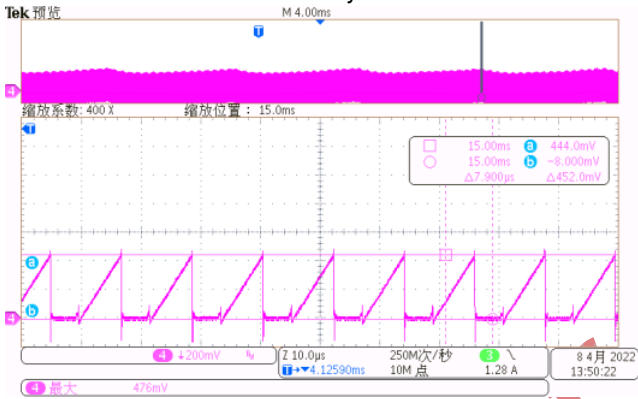

(CH4-Vcs)

Comments: Vcs=444mV, Rcs=0.36R, Ics=1.233A

Test Condition: 90Vac/60Hz Input, 15V Output, Overload

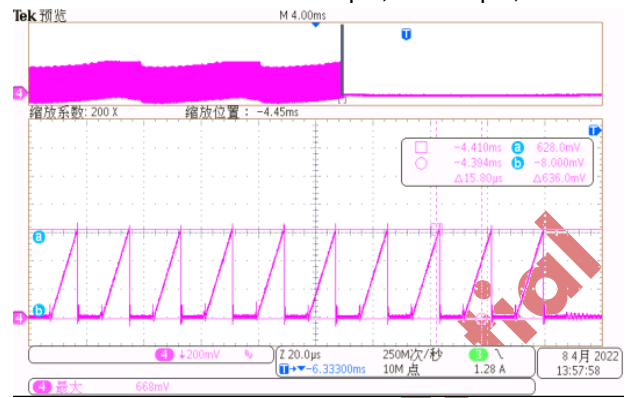

(CH4-Vcs)

Comments: Vcs=628mV, Rcs=0.36R, Ics=1.744A

Test Condition: 90Vac/60Hz Input, 20V Output, Overload

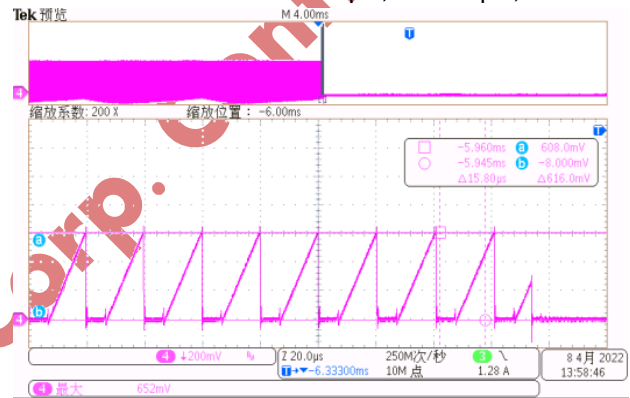

(CH4-Vcs)

Comments: Vcs=608mV, Rcs=0.36R, Ics=1.688A

4.3 Thermal Test

Test Condition: 90Vac/60Hz, 265Vac/50Hz input; 11V/3A、20V/1.5A output; Burn-in 1Hour @ confined container (30cm*30cm*30cm acrylic box) and steady environment with no airflow, Ta is the temperature inside the acrylic box.

Standard: MOS, IC and Diode: Ta=25°C, Trise<95°C. Transformer: Ta=25°C, Trise<85°C.

Result: Pass

Trise(°C)	11V/3A			
	Ta: 29°C			
Location	90V/60Hz		265V/50Hz	
	T(°C)	Trise(°C)	T(°C)	Trise(°C)
KP22062	104.2	75.2	91.4	62.4
KP40611WGA	99.7	70.7	92	63
Transformer	96	67	87	58
Bridge	123	94	75.1	46.1
Trise(°C)	20V/1.5A			
	Ta: 26°C			
Location	90V/60Hz		265V/50Hz	
	T(°C)	Trise(°C)	T(°C)	Trise(°C)
KP22062	80.3	54.3	89.3	63.3
KP40611	66	40	73.1	47.1
Transformer	73.2	47.2	79.6	53.6
Bridge	103.5	77.5	68.8	42.8

<p>Test Condition: 90Vac/60Hz Input, 11V/3A Output</p> <p>Comments: T-KP22062=104.2°C</p>	<p>Test Condition: 90Vac/60Hz Input, 11V/3A Output</p> <p>Comments: T-KP40611=99.7°C</p>
---	--

5 EMC/EMS Test Result

5.1 Conducted and Radiation Emissions

Standard:

standard	EN55022B/EN55015CDN
content	CE & RE
requirement	6dB margin

Result: Pass

Note: The resistor load is connected at the 1m Line end.

Test Condition: 220Vac/50Hz-L Input, 20V/1.5A Output

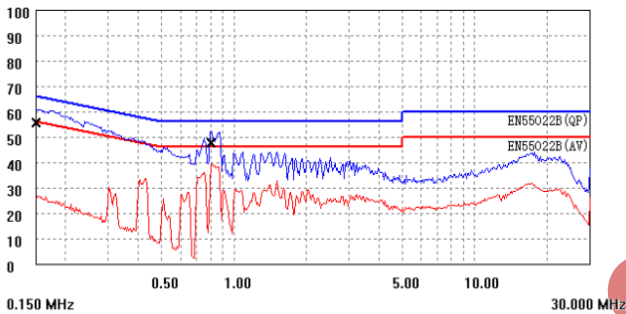

Test Condition: 220Vac/50Hz-N Input, 20V/1.5A Output

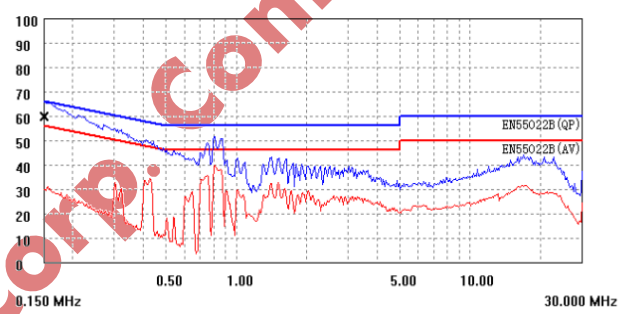

Test Condition: 220Vac/50Hz-L Input, 15V/2A Output

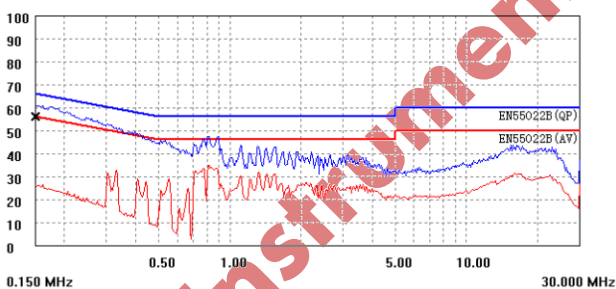

Test Condition: 220Vac/50Hz-N Input, 15V/2A Output

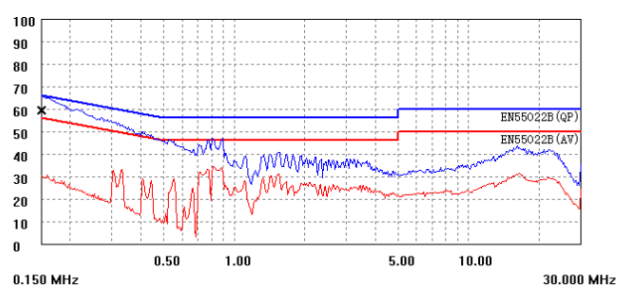

Test Condition: 220Vac/50Hz-L Input, 12V/2.5A Output

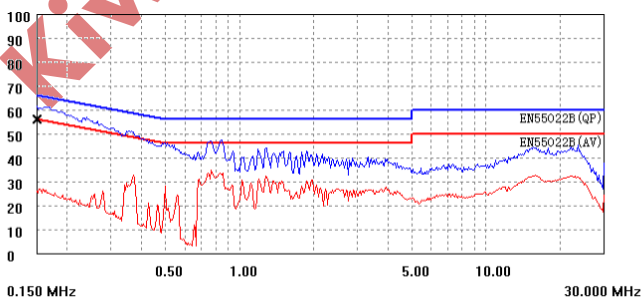

Test Condition: 220Vac/50Hz-N Input, 12V/2.5A Output

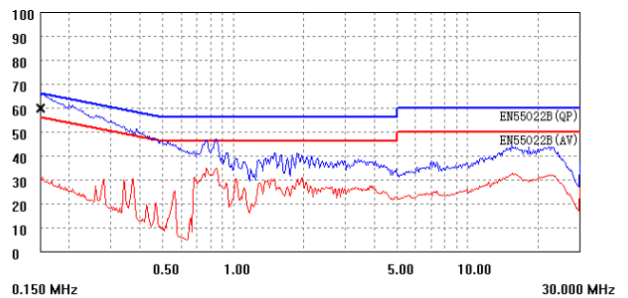



Demo Board Test Report
33W High Performance PD3.0 Charger
with Power Switch KP22062 and Synchronous Rectifier KP40611

Test Condition: 220Vac/50Hz-L Input, 11V/3A Output

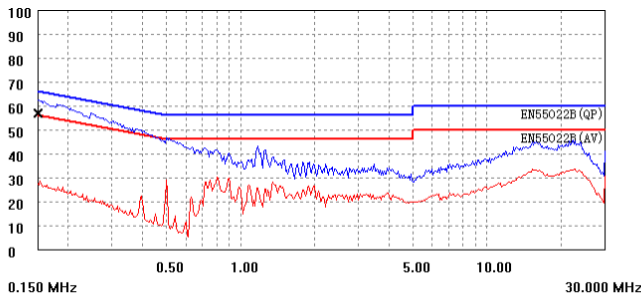

Test Condition: 220Vac/50Hz-N Input, 11V/3A Output

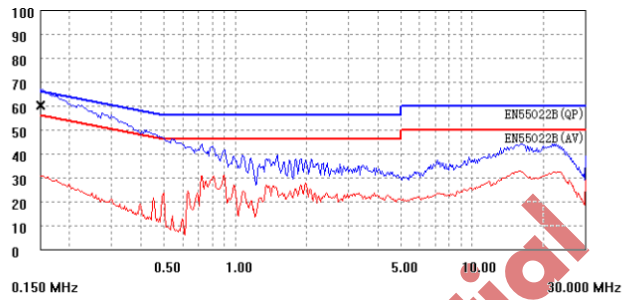

Test Condition: 220Vac/50Hz-L Input, 9V/3A Output

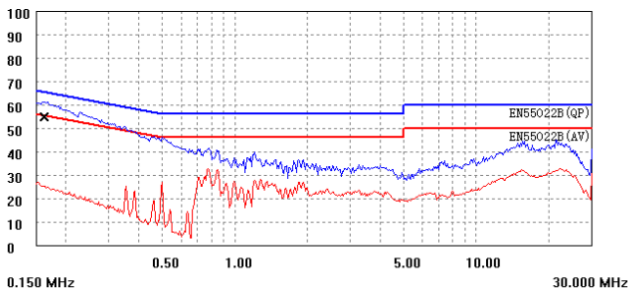

Test Condition: 220Vac/50Hz-N Input, 9V/3A Output

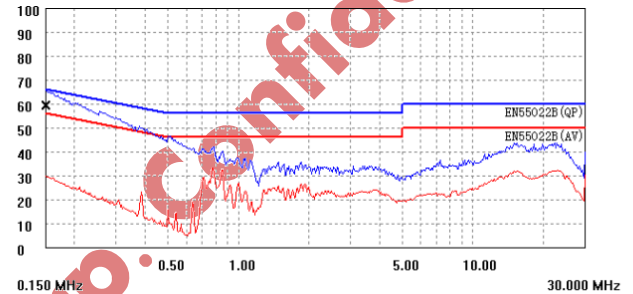

Test Condition: 220Vac/50Hz-L Input, 5V/3A Output

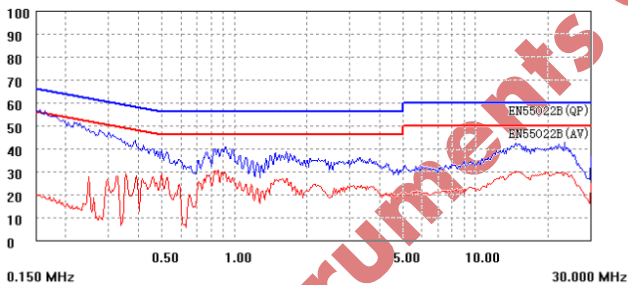

Test Condition: 220Vac/50Hz-N Input, 5V/3A Output

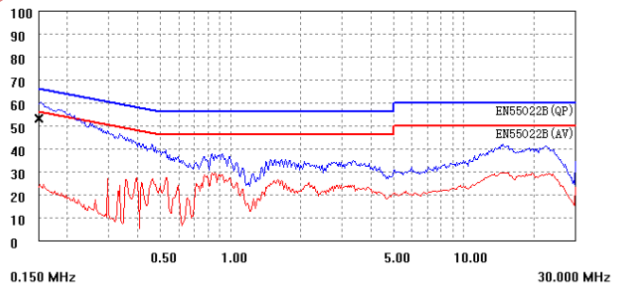

Test Condition: 110Vac/60Hz-L Input, 20V/1.5A Output

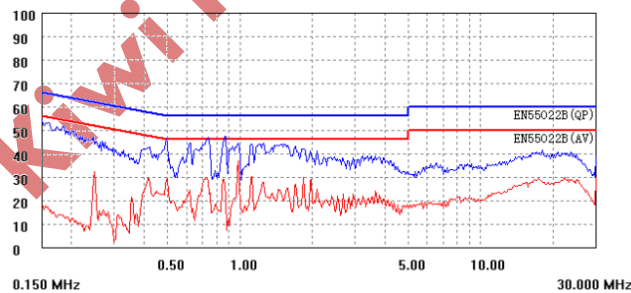

Test Condition: 110Vac/60Hz-N Input, 20V/1.5A Output

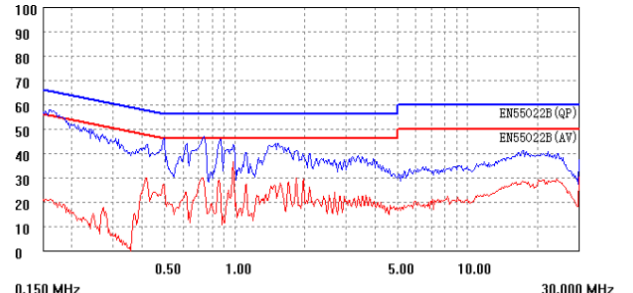



Demo Board Test Report
33W High Performance PD3.0 Charger
with Power Switch KP22062 and Synchronous Rectifier KP40611

Test Condition: 110Vac/60Hz-L Input, 15V/2A Output

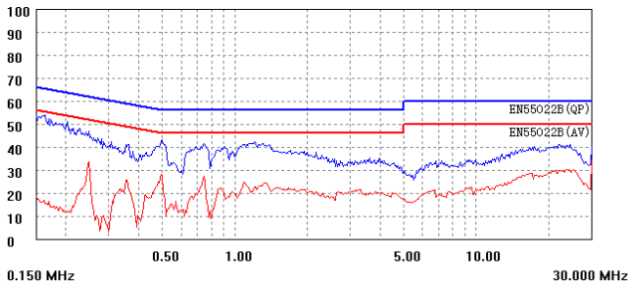

Test Condition: 110Vac/60Hz-N Input, 15V/2A Output

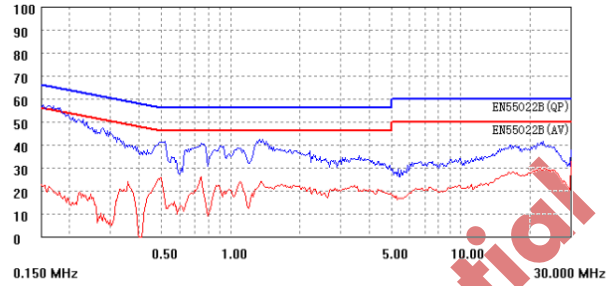

Test Condition: 110Vac/60Hz-L Input, 12V/2.5A Output

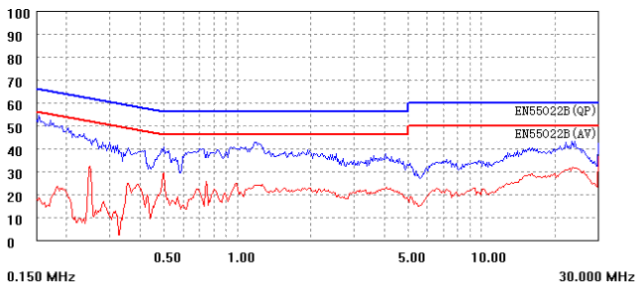

Test Condition: 110Vac/60Hz-N Input, 12V/2.5A Output

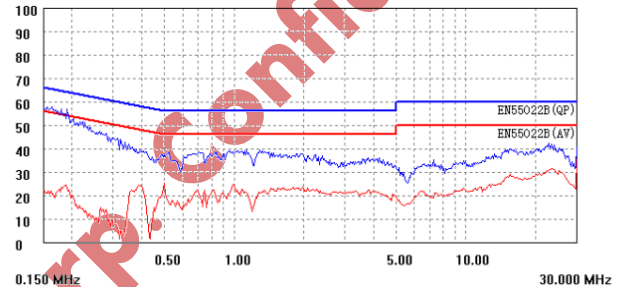

Test Condition: 110Vac/60Hz-L Input, 11V/3A Output

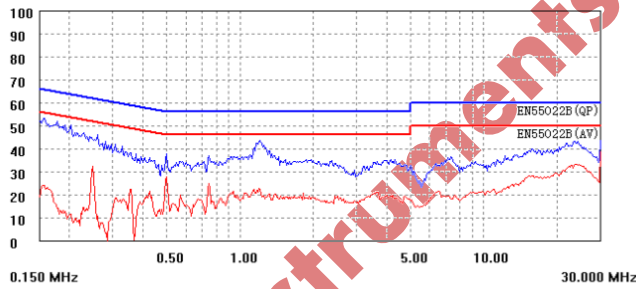

Test Condition: 110Vac/60Hz-N Input, 11V/3A Output

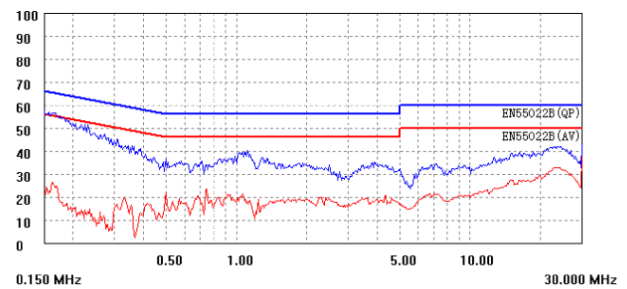

Test Condition: 110Vac/60Hz-L Input, 9V/3A Output

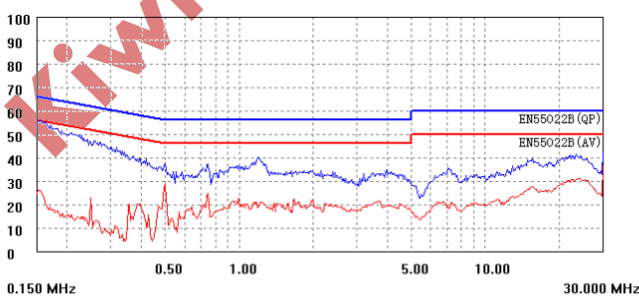

Test Condition: 110Vac/60Hz-N Input, 9V/3A Output

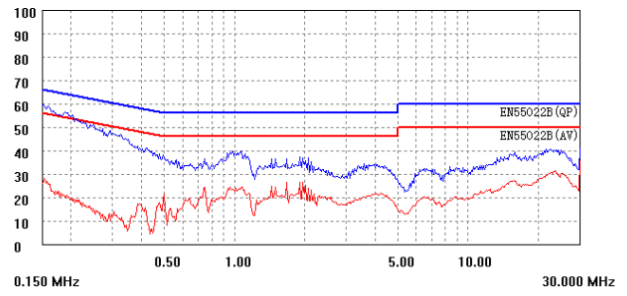



Demo Board Test Report
33W High Performance PD3.0 Charger
with Power Switch KP22062 and Synchronous Rectifier KP40611

Test Condition: 110Vac/60Hz-L Input, 5V/3A Output

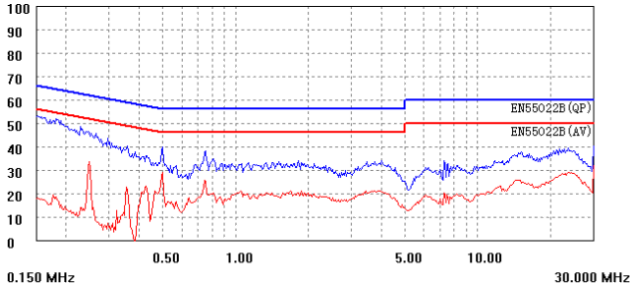

Test Condition: 110Vac/60Hz-N Input, 5V/3A Output

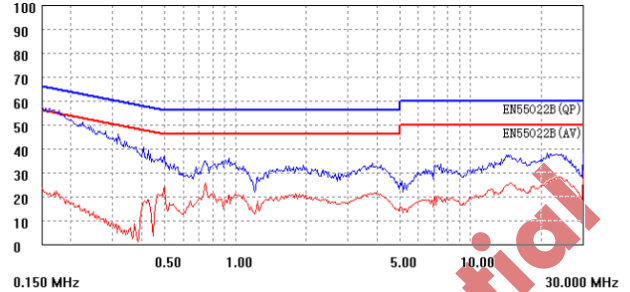

Test Condition: 220Vac/50Hz Input, 20V/1.5A Output

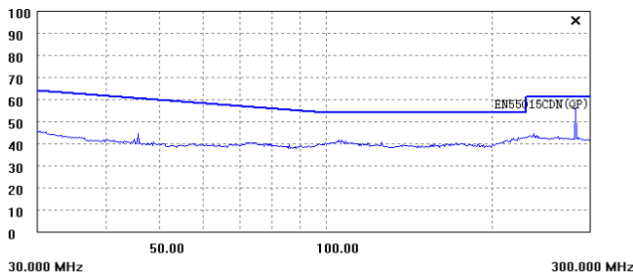

Test Condition: 110Vac/60Hz Input, 20V/1.5A Output

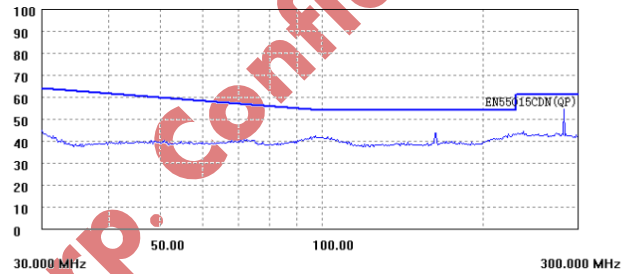

Test Condition: 220Vac/50Hz Input, 15V/2A Output

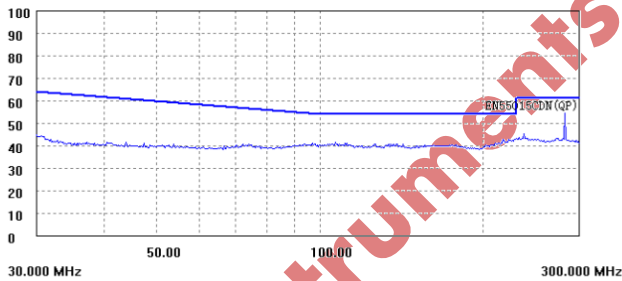

Test Condition: 110Vac/60Hz Input, 15V/2A Output

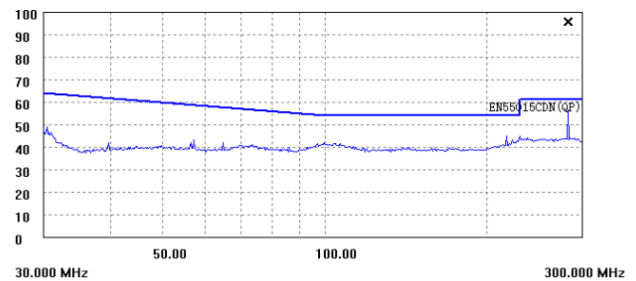

Test Condition: 220Vac/50Hz Input, 12V/2.5A Output

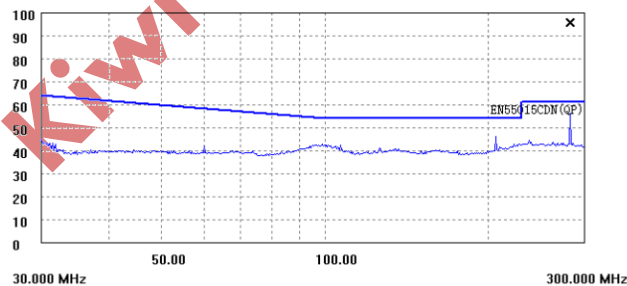

Test Condition: 110Vac/60Hz Input, 12V/2.5A Output

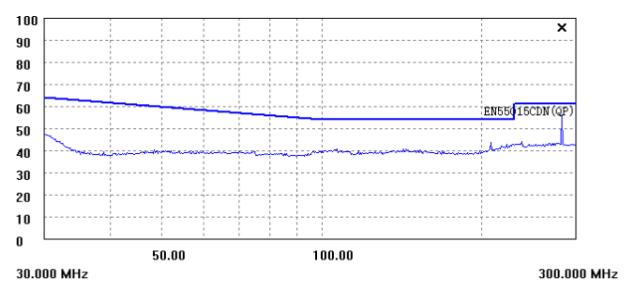



Demo Board Test Report
33W High Performance PD3.0 Charger
with Power Switch KP22062 and Synchronous Rectifier KP40611

Test Condition: 220Vac/50Hz Input, 11V/3A Output

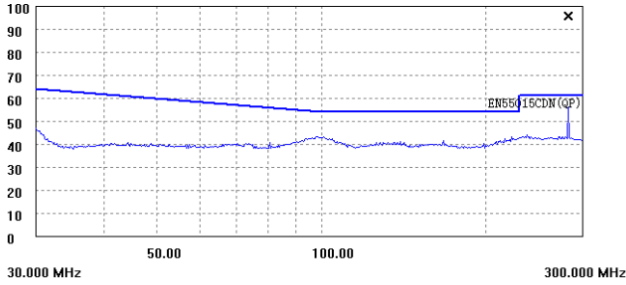

Test Condition: 110Vac/60Hz Input, 11V/3A Output

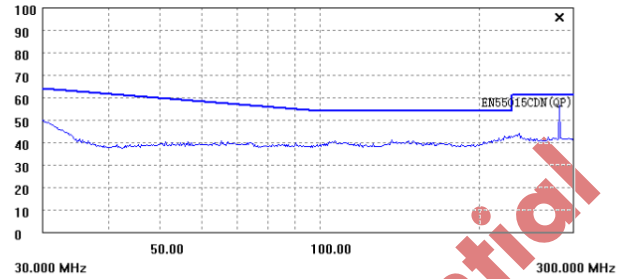

Test Condition: 220Vac/50Hz Input, 9V/3A Output

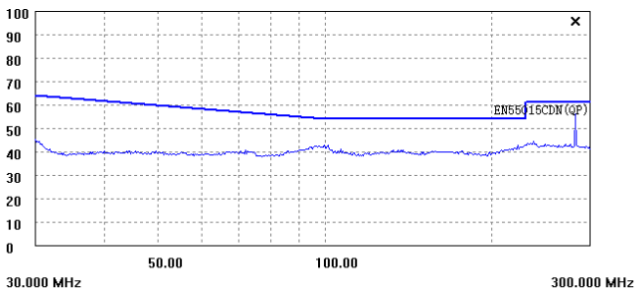

Test Condition: 110Vac/60Hz Input, 9V/3A Output

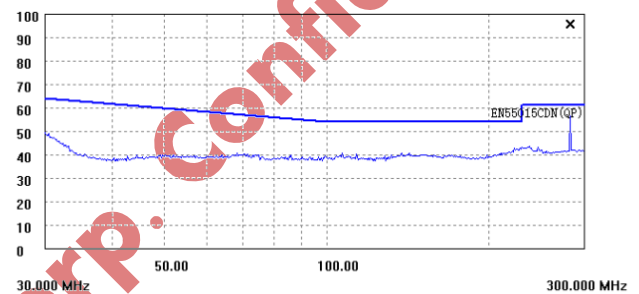

Test Condition: 220Vac/50Hz Input, 5V/3A Output

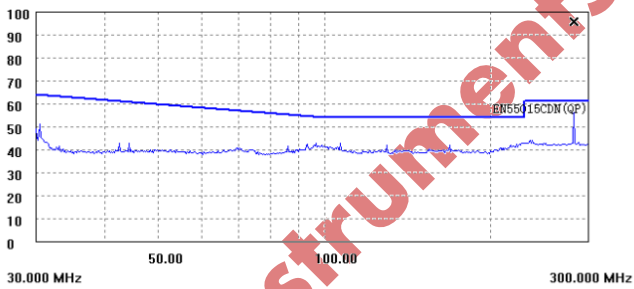

Test Condition: 110Vac/60Hz Input, 5V/3A Output

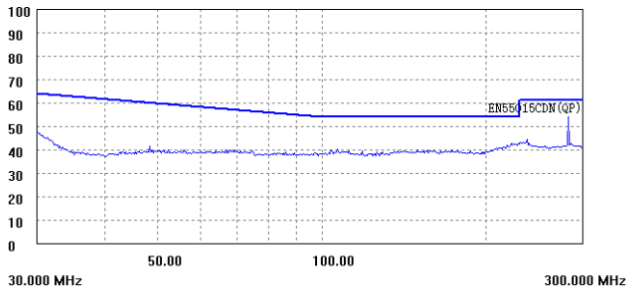



5.2 Surge Test

Test Condition: Input 220Vac/50Hz, output 20V/1.5A. Surge testing is completed according to IEC61000-4-5 each injection phase below is tested with 5 times and hold for 60 seconds before next one.

Standard: Level3, common mode voltage 2kV, difference mode voltage 1kV.

Result: Pass

Injection Location	Surge Level(V)	Injection Phase (°)	Test Result (Pass/Fail)
L to N	+1500	0	Pass
	+1500	90	Pass
	+1500	180	Pass
	+1500	270	Pass
	-1500	0	Pass
	-1500	90	Pass
	-1500	180	Pass
L to PE	+2500	0	Pass
	+2500	90	Pass
	+2500	180	Pass
	+2500	270	Pass
	-2500	0	Pass
	-2500	90	Pass
	-2500	180	Pass
N to PE	+2500	0	Pass
	+2500	90	Pass
	+2500	180	Pass
	+2500	270	Pass
	-2500	0	Pass
	-2500	90	Pass
	-2500	180	Pass
L+N to PE	+2500	0	Pass
	+2500	90	Pass
	+2500	180	Pass
	+2500	270	Pass
	-2500	0	Pass
	-2500	90	Pass
	-2500	180	Pass
-2500	270	Pass	



5.3 ESD Test

Test Condition: Input 220Vac/50Hz, output 20V/1.5A. Discharge 10 times on each output terminals at each test voltage according to IEC61000-4-2.

Standard: Level4, air discharge 15kV, contact discharge 8kV.

Result: Pass

Air Discharge		Contact Discharge	
Test Voltage (kV)	Result	Test Voltage (kV)	Result
16	Pass	9	Pass
-16	Pass	-9	Pass

Kiwi Instruments Corp. Confidential



Demo Board Test Report
33W High Performance PD3.0 Charger
with Power Switch KP22062 and Synchronous Rectifier KP40611

DATE	REV	DESCRIPTION
2022/06/27	1.0	First Release

Kiwi Instruments Corp. Confidential

Disclaimer

Kiwi reserves the right to make any change to its product, datasheet or specification without any notice. Users shall obtain the latest information before placing an order. Kiwi herein makes no guarantee or warranty, expressed or implied, including without limitation the warranties of merchantability, fitness for any purpose or non-infringement of third party rights, nor does Kiwi convey any license or permission including without limitation the intellectual property rights of Kiwi or any third party. Users should warrant that third party intellectual property right or other right is not infringed when integrating Kiwi products into any application or in use. Kiwi will not assume any liability arising from any said application or use, and especially disclaim any liability including without limitation any consequential or incidental damage. Without written declaration, Kiwi products are not designed for use in surgical device implant into the body or other life sustain systems. This disclaimer supersedes the disclaimers in previous versions.